



Tips voor een topdag

 **visiativ**



Connect 2024

Welkom!

3DEXPERIENCE

PRESENTATION BY FRANCESCO OORTHUIZEN AND RICHARD KATERBERG





Francesco OORTHUIZEN

3DEXPERIENCE WORKS Technical Partner Manager Benelux

Francesco.OORTHUIZEN@3ds.com

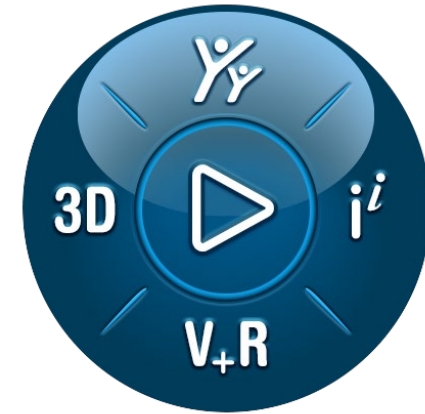

- 2022 until now 3DEXPERIENCE Technical Partner Manager Benelux @ DASSAULT
- 2020 until 2022 SOLIDWORKS Specialist @ Van der Hoeven Horticulture
- 2016 until now First Robotics CAD- Mentor @ 4481 Team Rembrandts
- 2011 until 2020 AE engineer / consultant @CADMES (VAR)
- SOLIDWORKS Champion since 2020
- SOLIDWORKS Elite Application Engineer since 2015
- SOLIDWORKS CSWE since 2012
- SOLIDWORKS Certified trainer since 2013

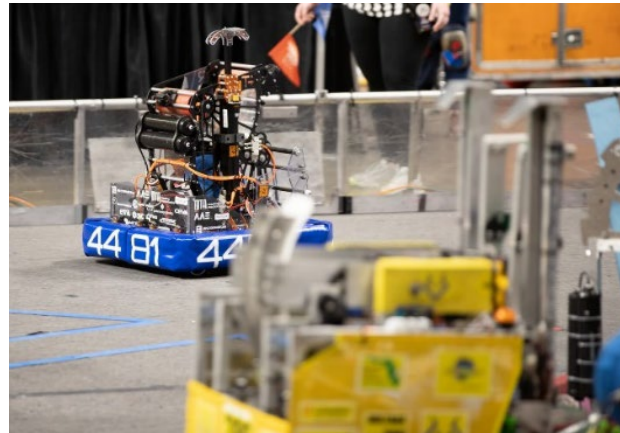

Introduction

—

- Richard Katerberg
- Aerospace engineer
- 39 Years of experience
- Catia & 3DEXP user and specialist
- Consultant @ Visiativ Benelux



Explain the platform from different point of views



What is the 3DEXPERIENCE PLATFORM

—

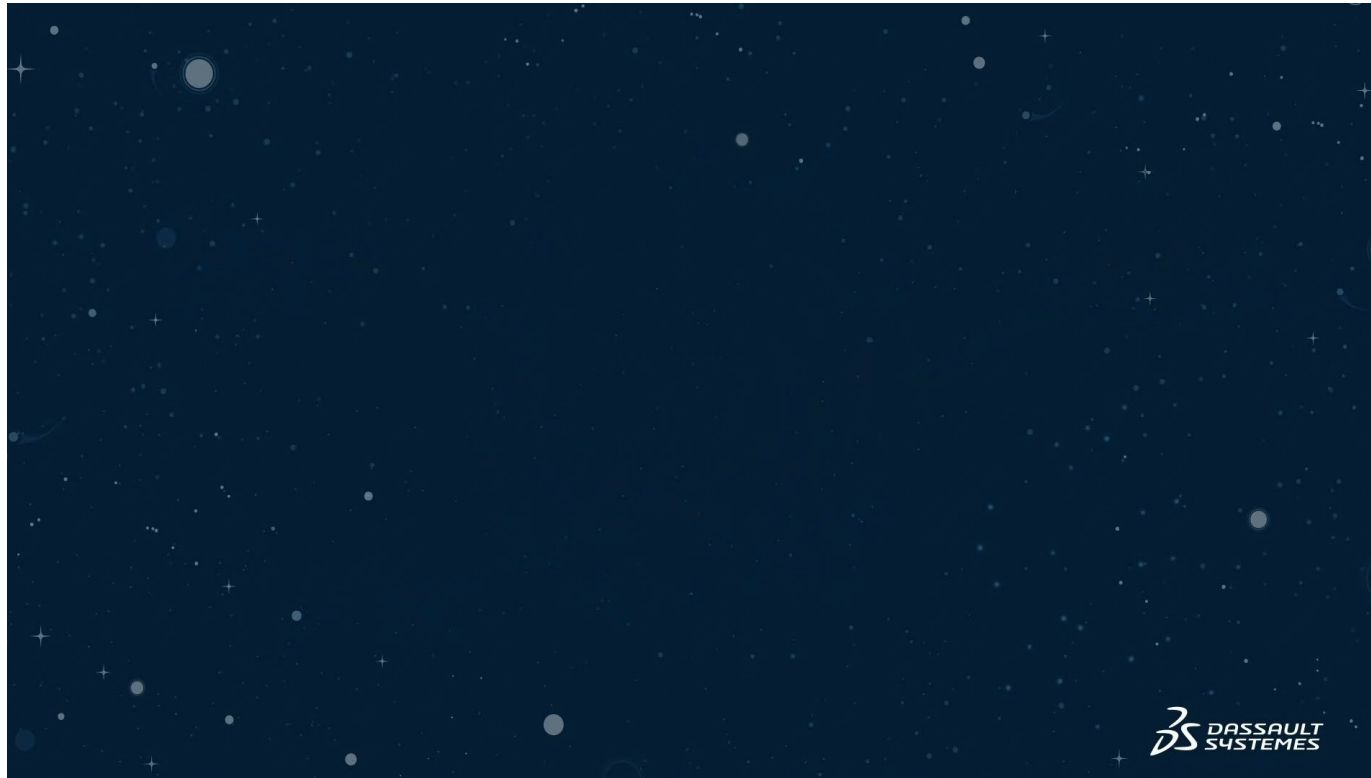



What is the 3DEXPERIENCE Platform

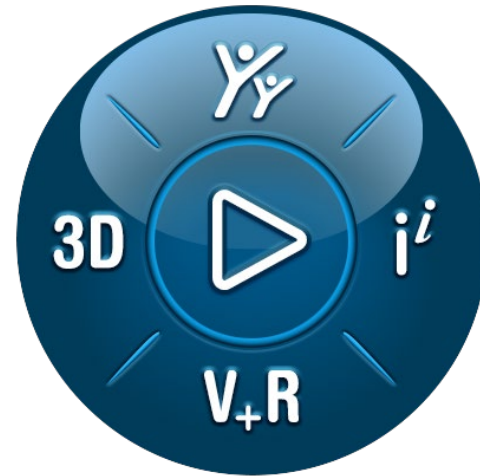

What is the 3DEXPERIENCE Platform

- Operating system / business platform

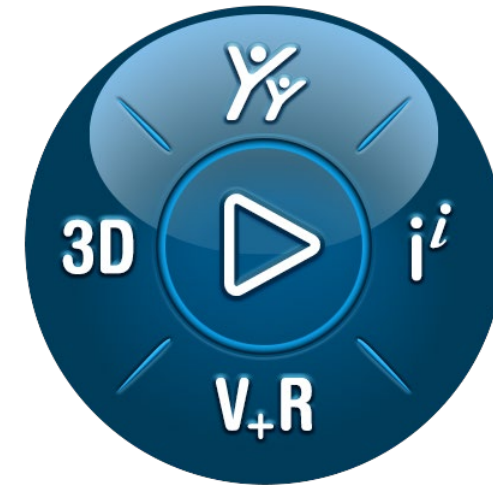
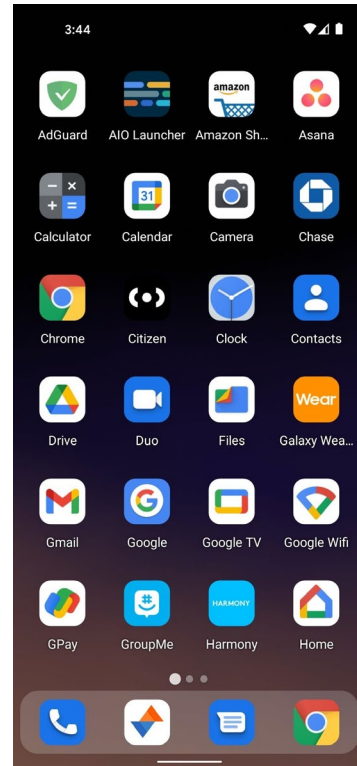

digital continuity



Connecting the dots

—

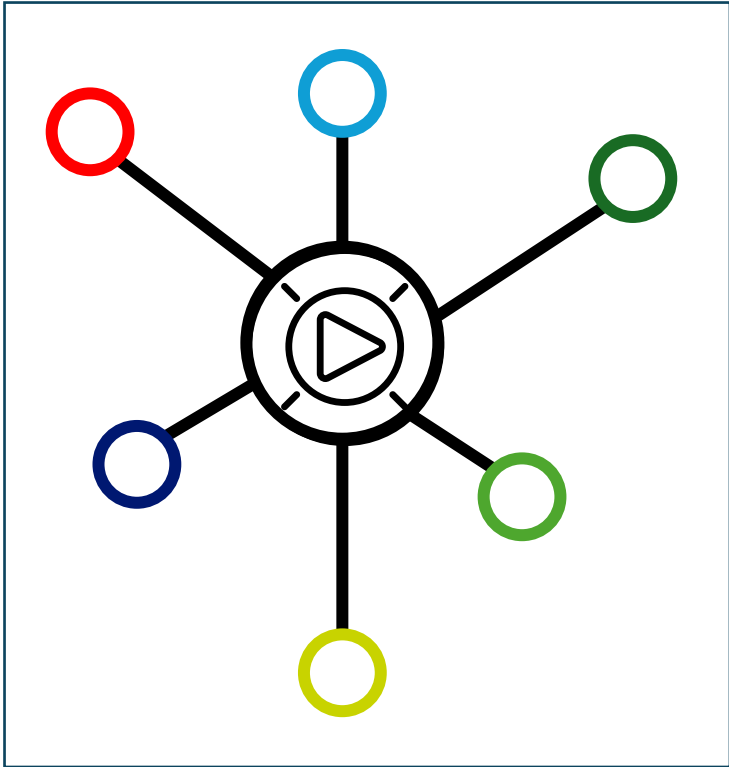
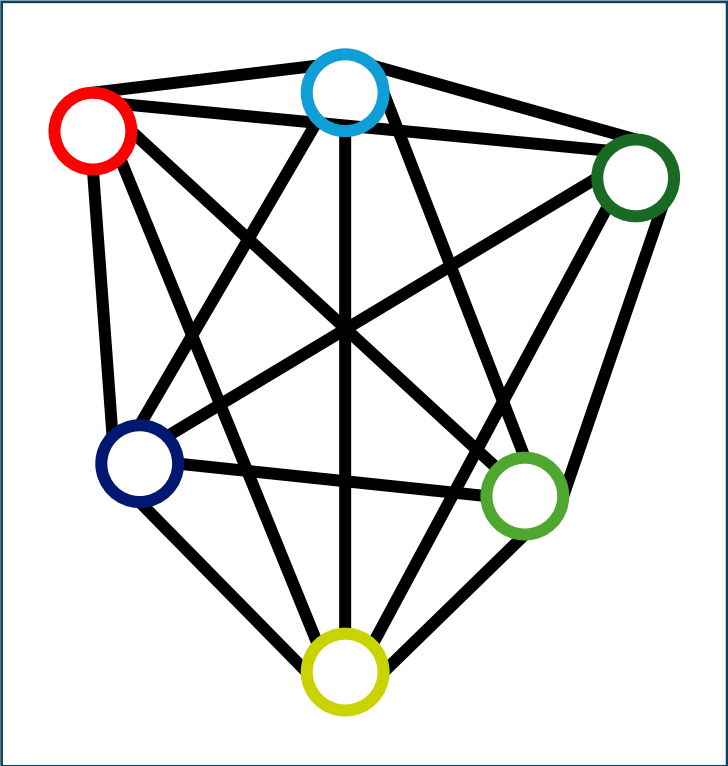

Removing Silos

—

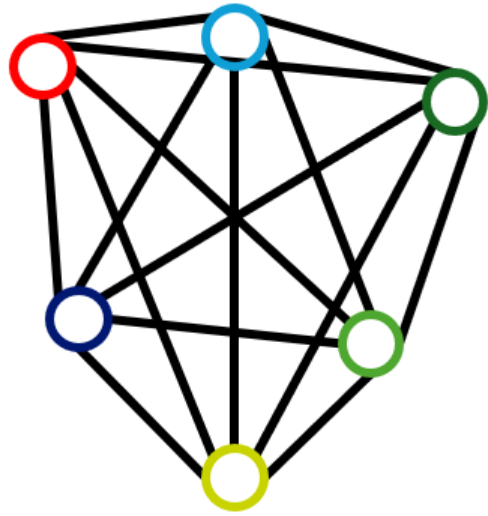

Mechanical Engineering



Manuf. Engineering



Design

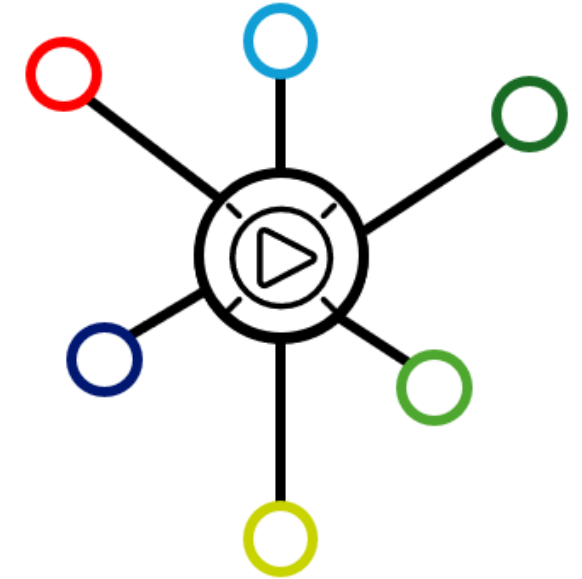

Marketing & Sales

Electronic Communications

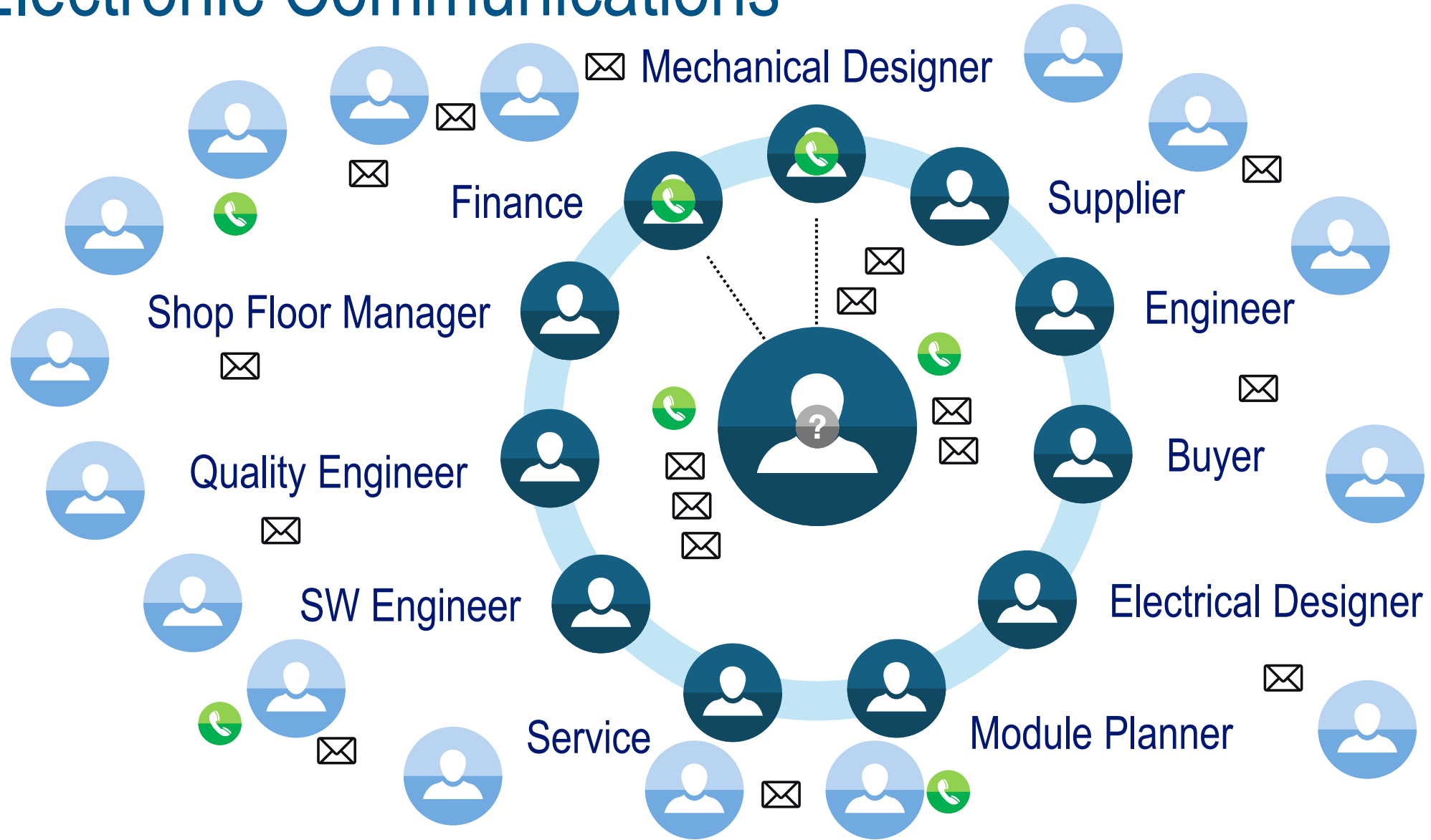

Digital Communications

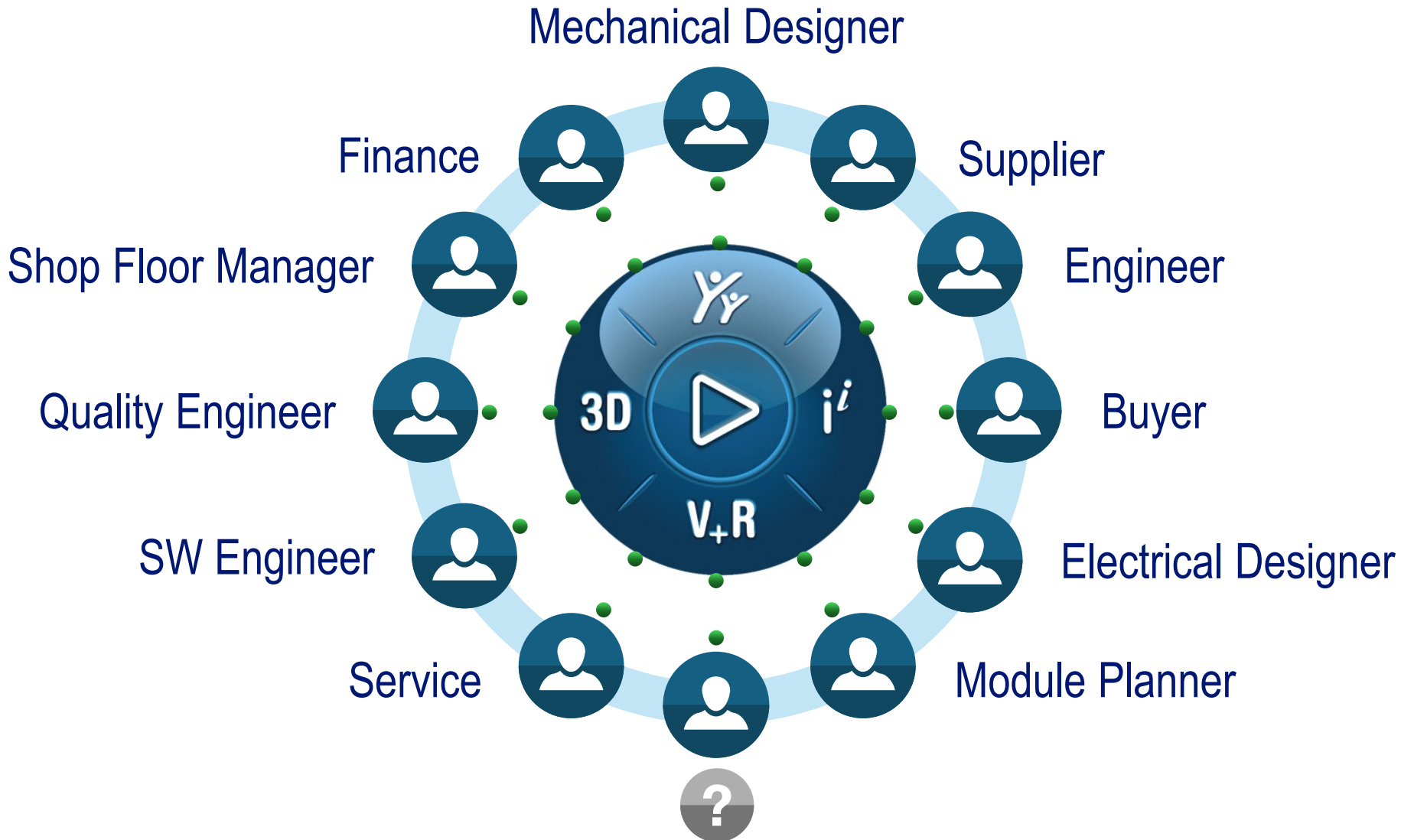

Dassault Systemes 3DEXPERIENCE platform

—

Brands



Platform

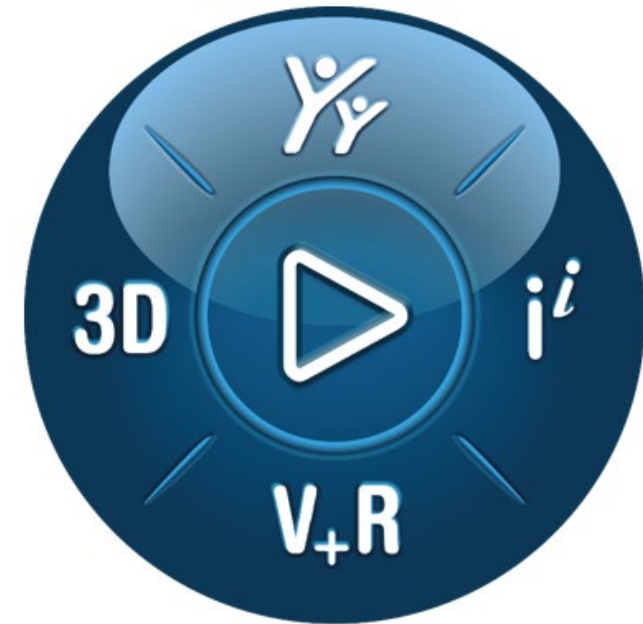

Dassault Systemes 3DEXPERIENCE platform

AUTODESK
INVENTOR®

SIEMENS

NX

creo®



Office



PDM's
ERP

...

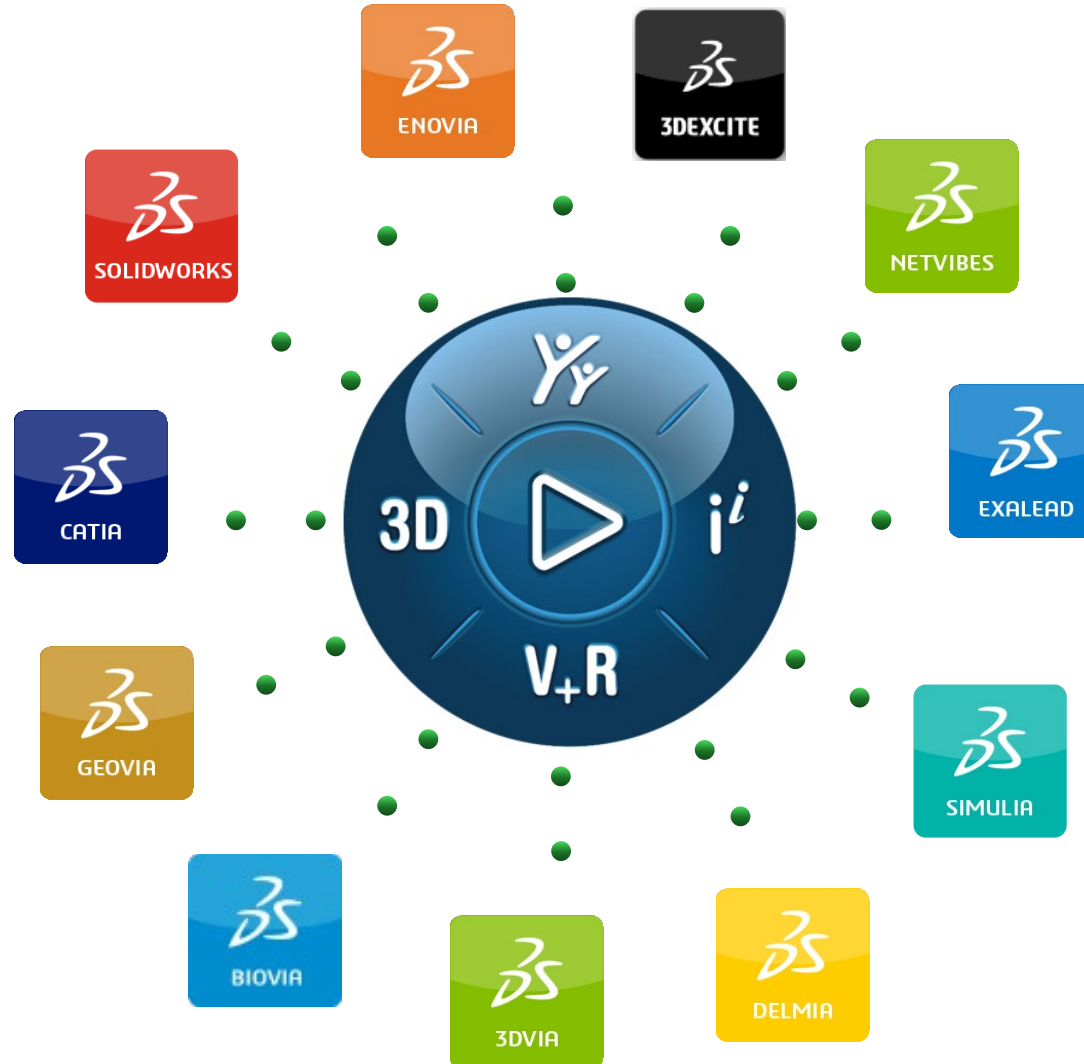

Current situation @ companies

-

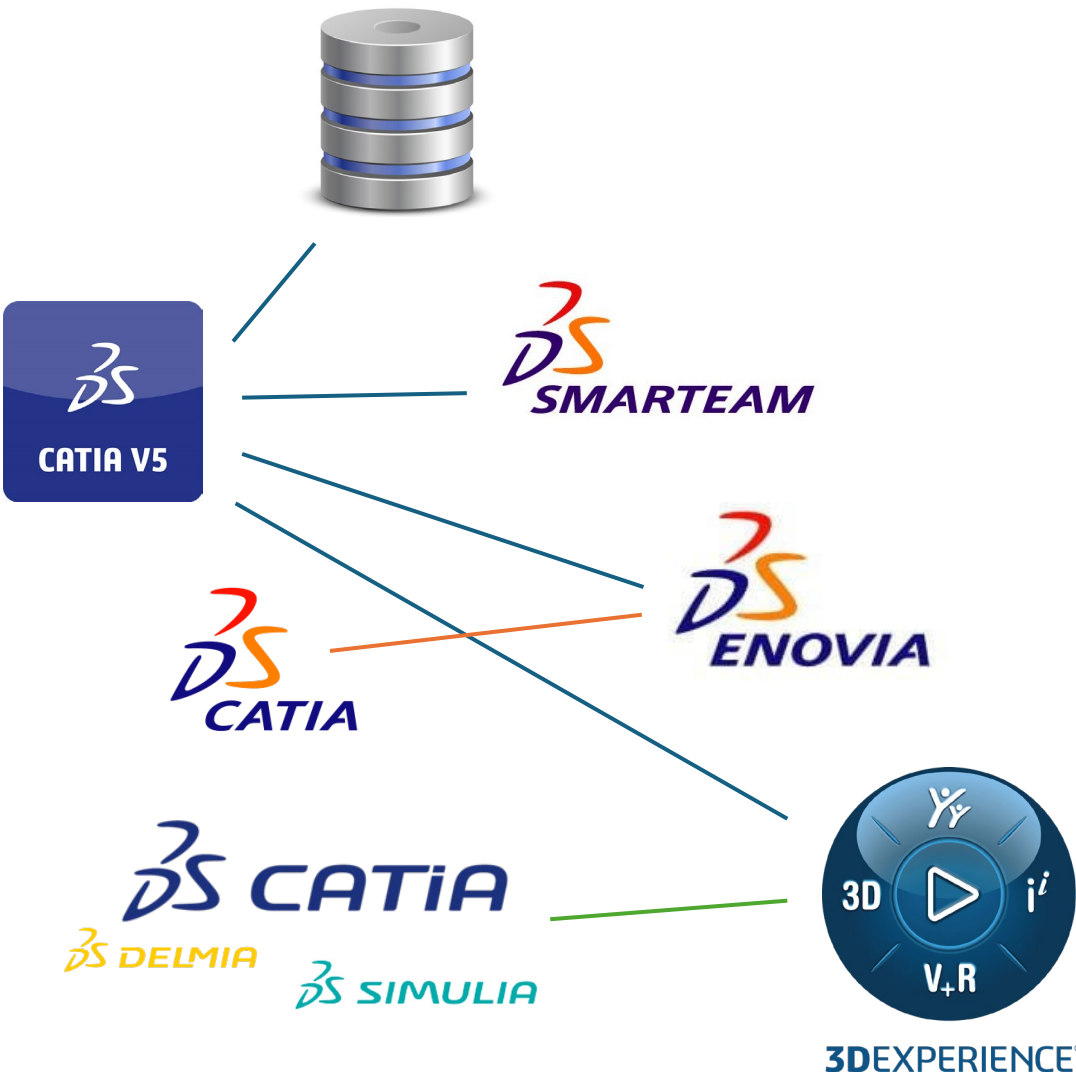
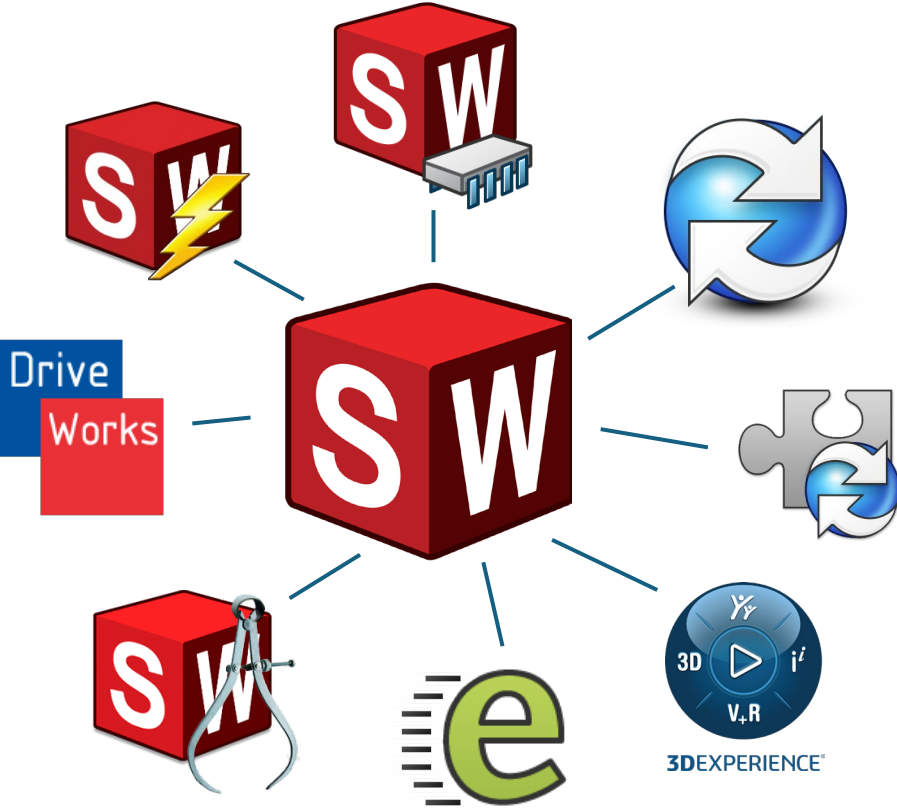

Processes in a company, just an example

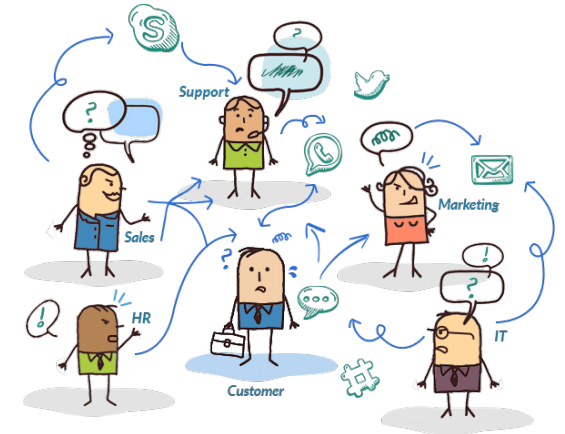
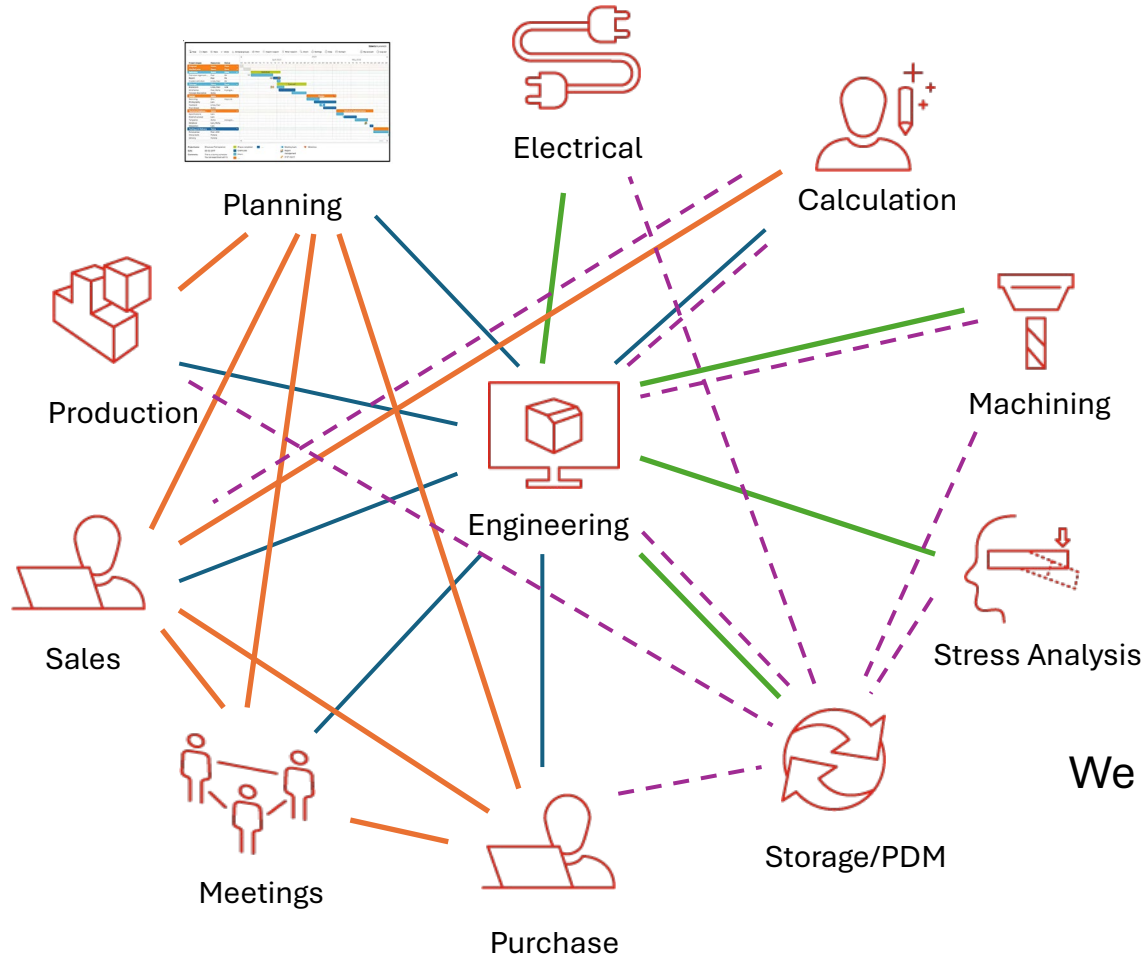

How do we streamline the processes in our company ...

How can we reduce hard and software
~~We are looking into machines~~
 We are looking into machines. We are looking into the CLOUD ...

Where do we store our documentation,
 NC programs, drawings and offers ...

We would like to do as much as possible in 1 system ...

3DEXperience platform



3Dspace



Documents app



Issue management



Approvals

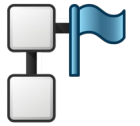

Routes

Collaborative
industry
innovator



DMS/PDM/PLM/ Review



3DSWYMER



Basis access to 3DEXperience platform

3DExperience platform

—



Basic platform access

DMS/PDM/PLM/ Review

Basis access to 3DExperience platform

3DEXperience platform

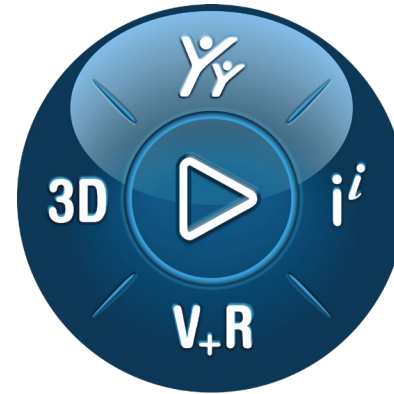

3DEXPERIENCE®

Cloud services

3DEXPERIENCE Connector to Catia and Solidworks

DMS/PDM/PLM/ Review

Basis access to 3DExperience platform

3DExperience platform



BOM management



Structure editor



Change management

Bom management & Change management

Cloud services

3DEXPERIENCE Connector to Catia and Solidworks

DMS/PDM/PLM/ Review

Basis access to 3DExperience platform

Cloud services – 3 Easy steps

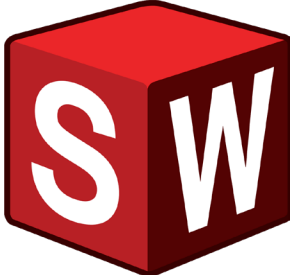

Store and Revise

Share and Markup

Manage and Control

Cloud services

- 3DEXPERIENCE Connector to Catia and Solidworks
- DMS/PDM/PLM/ Review
- Basis access to 3DExperience platform



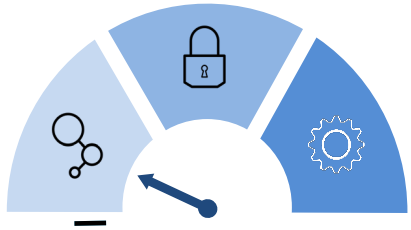

Share and Markup

View in a browser, No need to download special viewers

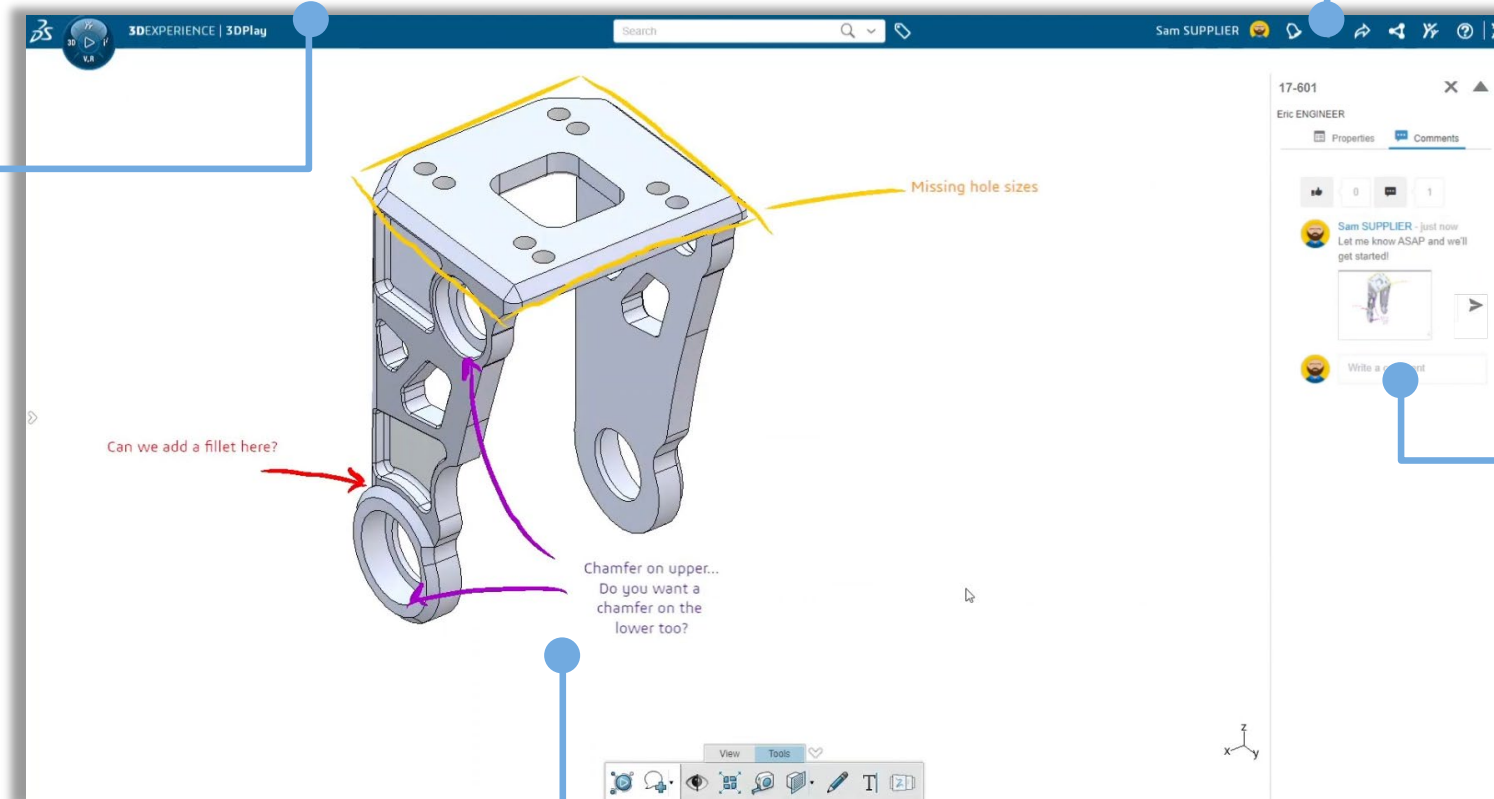

Share a secure link. Never lose control of your data.

Share comments and collaborate on your design. Get immediate feedback from those you trust.

Create mark ups directly on the 3D model to capture ideas and communicate changes.

Share and Markup use case



Dan DESIGNER

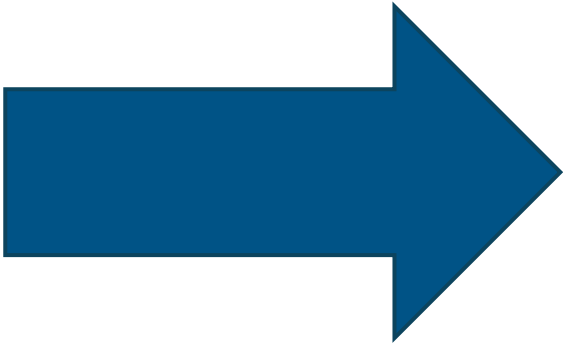

Charlie Client

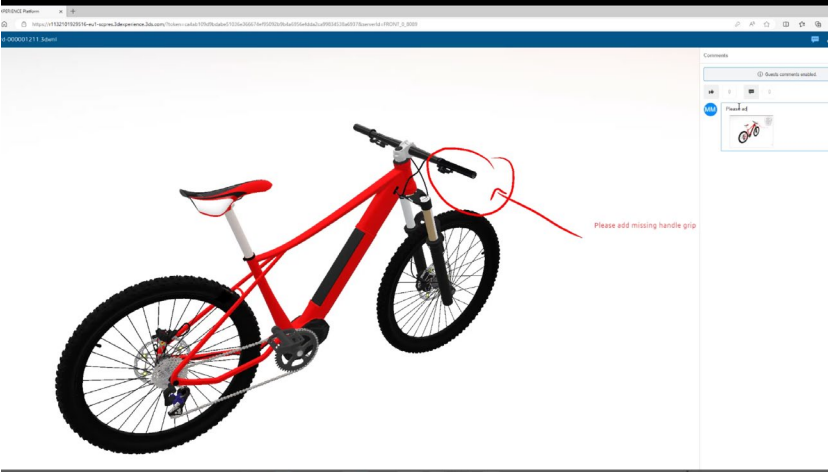
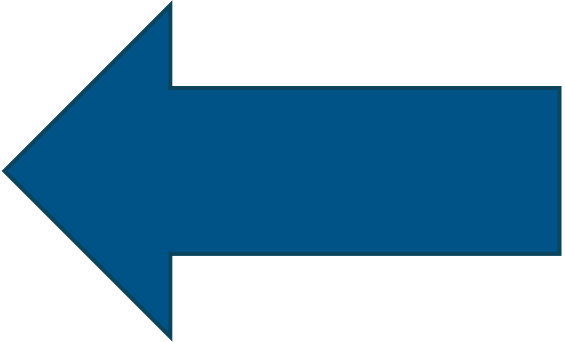
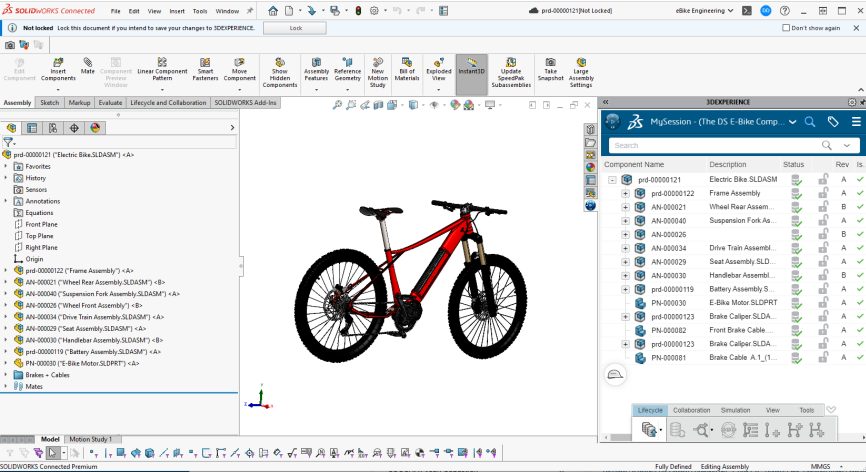



Charlie.Client's inbox > "Dan Designer shared prd-00000121.3dxml with you."

Message "Dan Designer shared prd-00000121.3dxml with you. "

From: "3DEXPERIENCE platform [The DS E-Bike Company]" <noreply@3dexperience.3ds.com>

[Back to inbox](#) | [Download EML](#) | [Delete message](#)

Click [here](#) if you trust the sender and want to see original message.

3DEXPERIENCE platform
Someone shares some content with me

Dear User ,

Dan Designer shared **prd-00000121.3dxml** with you.
[Click here to see more.](#)
Important note: You can only accept this invitation by logging in with the email address to which this email was sent.

Best Regards,
Dassault Systèmes

This email and any attachments are intended solely for the use of the individual or entity to whom it is addressed and may be confidential and/or privileged.

If you are not one of the named recipients or have received this email in error,

- (i) you should not read, disclose, or copy it,
- (ii) please notify sender of your receipt by reply email and delete this email and all attachments,
- (iii) Dassault Systemes does not accept or assume any liability or responsibility for any use of or reliance on this email.

For other languages, <http://www.3ds.com/terms/email-disclaimer>

[Contact](#) | Unread messages older than 2 days, and read older than 2 months are automatically deleted.

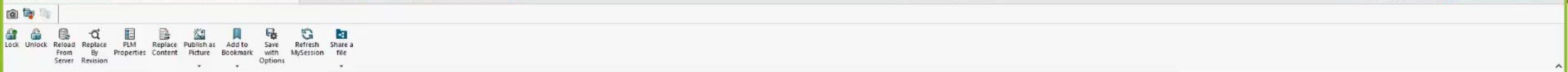

- prd-0000121 ("Electric Bike.SLDASM") <A>
- Favorites
- History
- Sensors
- Annotations
- Equations
- Front Plane
- Top Plane
- Right Plane
- Origin
- prd-0000122 ("Frame Assembly") <A>
- AN-000021 ("Wheel Rear Assembly.SLDASM")
- AN-000040 ("Suspension Fork Assembly.SLDASM") <A>
- AN-000026 ("Wheel Front Assembly")
- AN-000034 ("Drive Train Assembly.SLDASM") <A>
- AN-000029 ("Seat Assembly.SLDASM") <A>
- AN-000042 ("Handlebar Assembly.SLDASM") <A>
- prd-0000119 ("Battery Assembly.SLDASM") <A>
- PN-000030 ("E-Bike Motor.SLDPRT") <A>
- Brakes + Cables
- Mates



3DEXPERIENCE

3DDrive - The DS E-Bike ... Search The DS E-Bike

- The DS E-Bike Company
- Profile
- Notifications
- Help

Update 3DEXPERIENCE Drive ...

Share and Markup Benefits

—

- Share secure links from SOLIDWORKS and never lose control of your data
- Create markups directly on the 3D model in a browser - no install or license needed
- Get immediate feedback to keep your project moving
- Recipient needs **NO** license and **NO** software

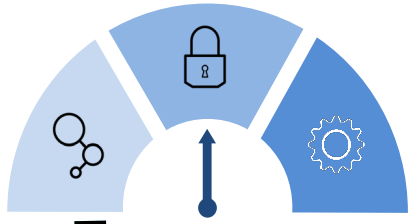

Store and Revise

Save your data to the cloud right from SOLIDWORKS

Online storage that's purpose-built with CAD relationships and collaboration in mind.

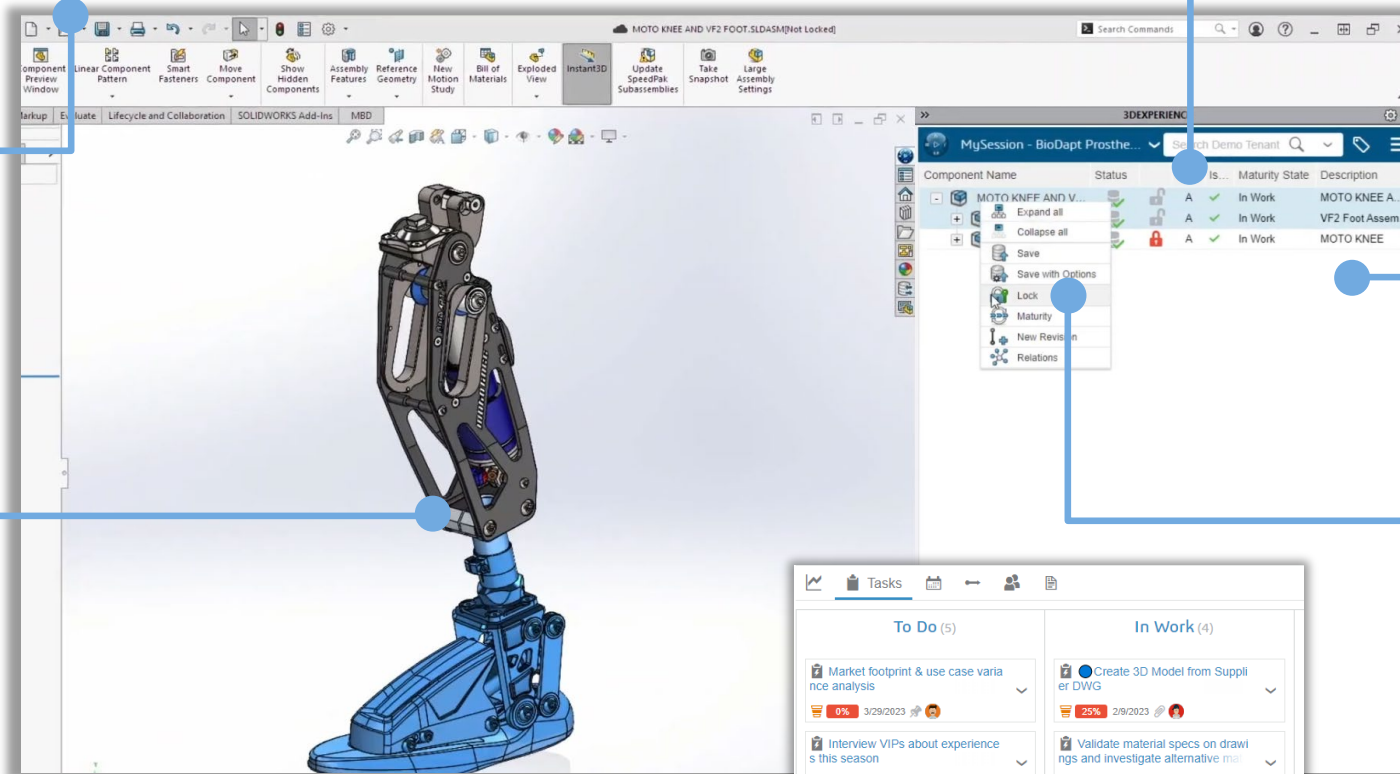

Add designs to a task and assign it for follow-up

Bump revision with a simple right click

Your data is organized, References are managed, custom properties are captured

Need to work with other designers? No problem, simply lock the design to ensure no one else overwrites your work.

Store & revise



Charlie Client

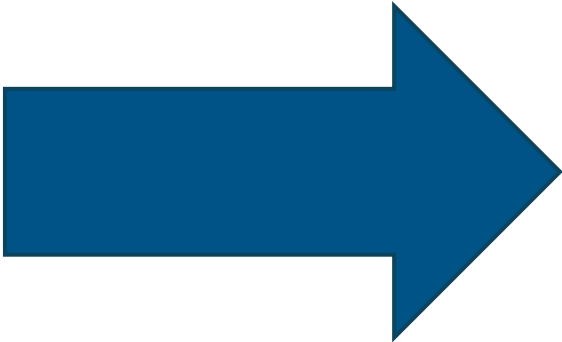

Dan DESIGNER

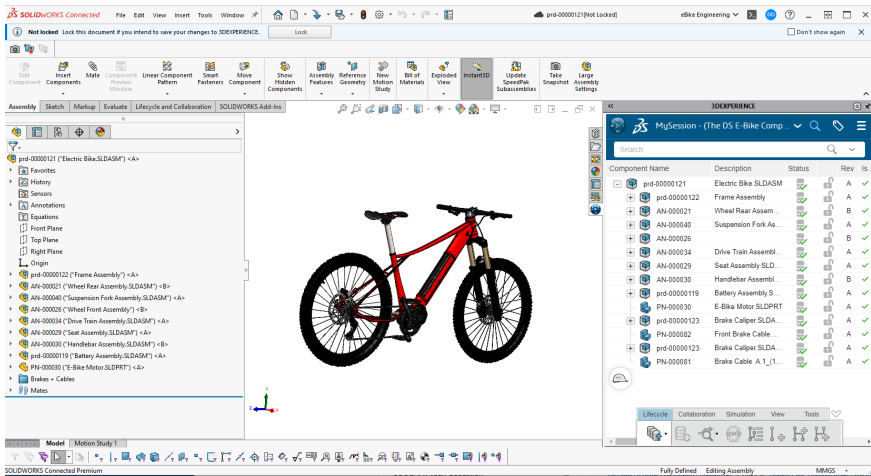
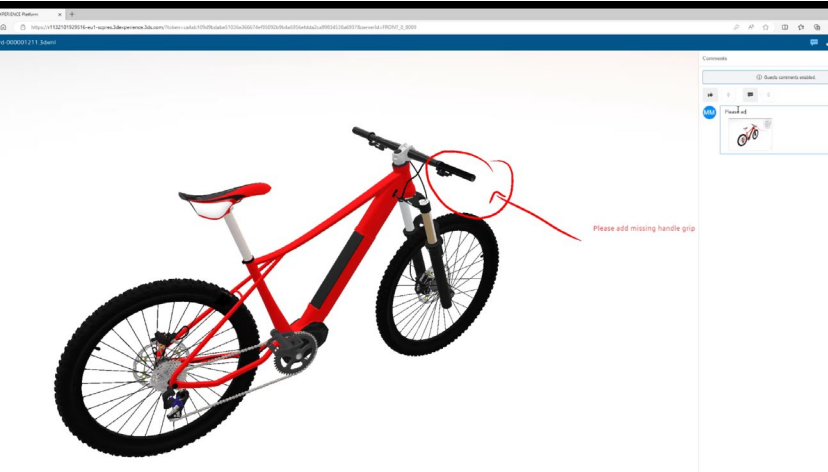

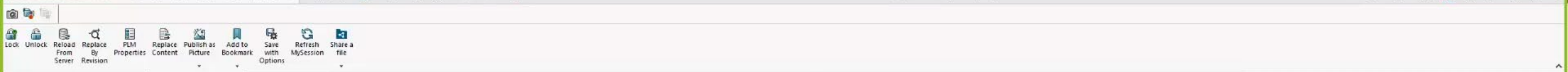

- prd-0000121 ("Electric Bike.SLDASM") <A>
- Favorites
- History
- Sensors
- Annotations
- Equations
- Front Plane
- Top Plane
- Right Plane
- Origin
- prd-0000122 ("Frame Assembly") <A>
- AN-000021 ("Wheel Rear Assembly.SLDASM")
- AN-000040 ("Suspension Fork Assembly.SLDASM") <A>
- AN-000026 ("Wheel Front Assembly")
- AN-000034 ("Drive Train Assembly.SLDASM") <A>
- AN-000029 ("Seat Assembly.SLDASM") <A>
- AN-000042 ("Handlebar Assembly.SLDASM") <A>**
- prd-0000119 ("Battery Assembly.SLDASM") <A>
- PN-000030 ("E-Bike Motor.SLDPRNT") <A>
- Brakes + Cables
- Mates



Component Name	Status	Rev	Is ...	Maturity State	Desc
prd-0000121		A	✓	In Work	Electri
prd-0000122		A	✓	In Work	Frame
AN-000021		B	✓	Released	Wheel
AN-000040		A	✓	Released	Suspe
AN-000026		B	✓	Released	
AN-000034		A	✓	Released	Drive
AN-000029		A	✓	Released	Seat A
AN-000042		A	✓	Released	Handle
prd-0000119		A	✓	In Work	Batter
PN-000030		A	✓	Released	E-Bike
prd-0000123		A	✓	Released	Brake
prd-000082		A	✓	Released	Front f
prd-0000123		A	✓	Released	Brake
PN-000081		A	✓	Released	Brake

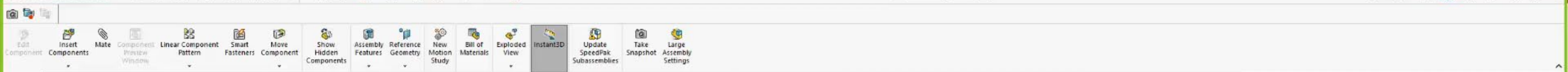

Assembly Sketch Markup Evaluate Lifecycle and Collaboration SOLIDWORKS Add-Ins

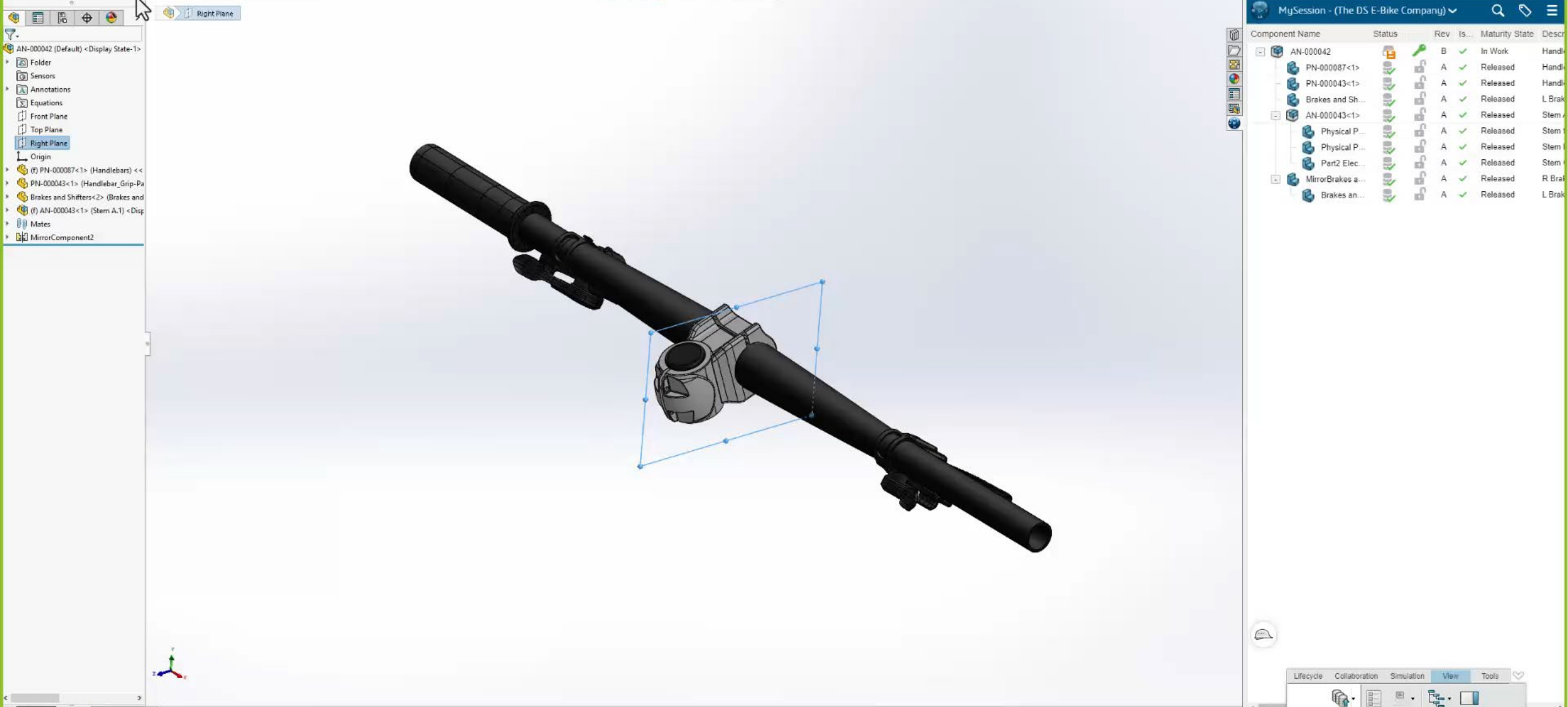

- AN-000042 (Default) <Display State-1>
- Folder
- Sensors
- Annotations
- Equations
- Front Plane
- Top Plane
- Right Plane
- Origin
- (f) PN-000087<1> (Handlebars) <<
- PN-000043<1> (Handlebar_Grip-Pa
- Brakes and Shifters<2> (Brakes and
- (f) AN-000043<1> (Stem A.1) <Disp
- Mates
- MirrorComponent2

3DEXPERIENCE MySession - (The DS E-Bike Company)

Component Name	Status	Rev	Is...	Maturity State	Desi
AN-000042		B	✓	In Work	Handl
PN-000087<1>		A	✓	Released	Handl
PN-000043<1>		A	✓	Released	Handl
Brakes and Sh...		A	✓	Released	L Brak
AN-000043<1>		A	✓	Released	Stem A
Physical P...		A	✓	Released	Stem
Physical P...		A	✓	Released	Stem f
Part2 Elec...		A	✓	Released	Stem
MirrorBrakes a...		A	✓	Released	R Brak
Brakes an...		A	✓	Released	L Brak

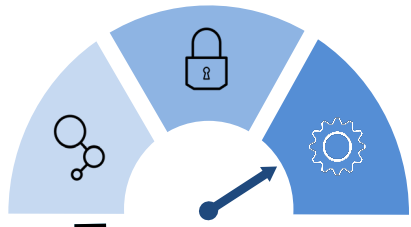

Manage and Control

Get the approvals needed and control the workflow through formal change actions

The screenshot displays the 3DEXPERIENCE software interface. At the top, a 3D model of a knee joint is visible. Below it, a table lists component maturity states for 'MOTO KNEE B'. The table has columns for Component Name, Status, Rev, Is..., Maturity State, and Description. A workflow diagram below the table shows the progression from Private to In Work, then to Frozen, Released, and finally Obsolete. A 'Change' button is highlighted in the diagram.

Component Name	Status	Rev	Is...	Maturity State	Description
MOTO KNEE	In Work	B	✓	In Work	MOTO KNEE
17-899<3>	In Work	B	✓	In Work	LOWER BRACKET
17-840<1>	Released	A	✓	Released	TOP PIVOT MOUNT
17-845<1>	Released	A	✓	Released	CLEVIS
17-843<1>	Released	A	✓	Released	ROD END
17-862<1>	Released	A	✓	Released	BRONZE BUSHING...
17-847<1>	Released	A	✓	Released	SHAFT-TRACK
17-846<1>	Released	A	✓	Released	BUSHING - CLEVI...
17-846<2>	Released	A	✓	Released	BUSHING - CLEVI...
17-849<1>	Released	A	✓	Released	SPACER

Easily release the design change to let the team know it is ready for production

Capture and track changes and issues

ENOVIA - Properties - VF2

VF2 B
Eric ENGINEER 12/8/2022, 8:22:44 AM

Change Required:

Release Authorization:

Linkage Design
CA-00000129 | Eric ENGINEER
Completed | 2022-12-16

Order	Title	Approver	Status	Comments	Approval Date
1	Manufacturing App.	Sam SUPPLIER	Approve	Manufacturing App.	Dec 7, 2022
1	Quality Approval	Dan DESIGNER	Approve	Quality Approved	Dec 7, 2022
2	Product Management	Pete PROJECT	Approve	Product Management	Dec 7, 2022
3	Purchasing Approval	Debbie DESIGNER	Approve	Purchasing Approved	Dec 7, 2022
3	Purchasing Approval	Ben BUSINESS	Approve	This task is Auto C.	Dec 7, 2022
3	Purchasing Approval	Megan MANAGER	Approve	This task is Auto C.	Dec 7, 2022
4	Approval	Eric ENGINEER	Approve	Engineering Appro...	Dec 8, 2022

Manage & Control



Lee ENGINEER

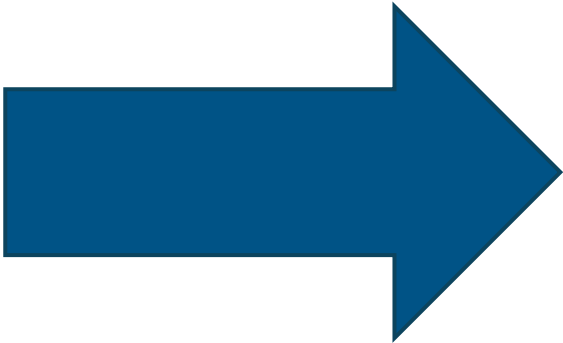

Debbie External

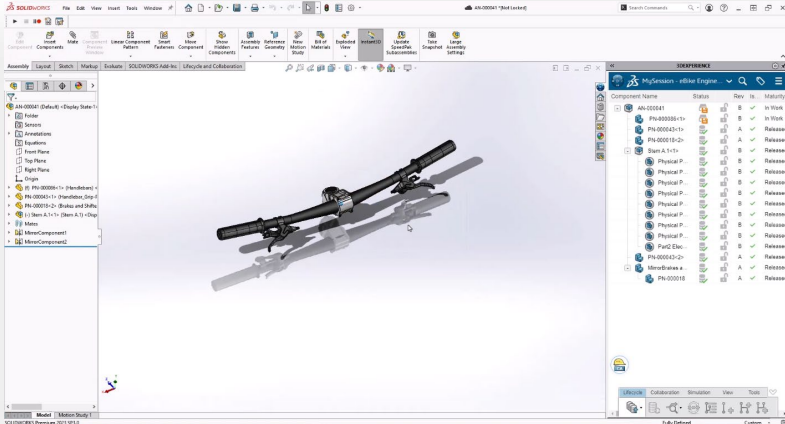
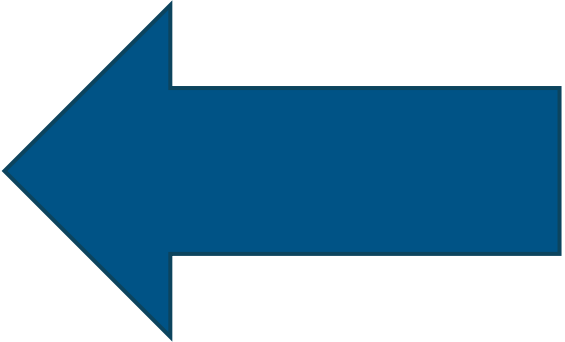
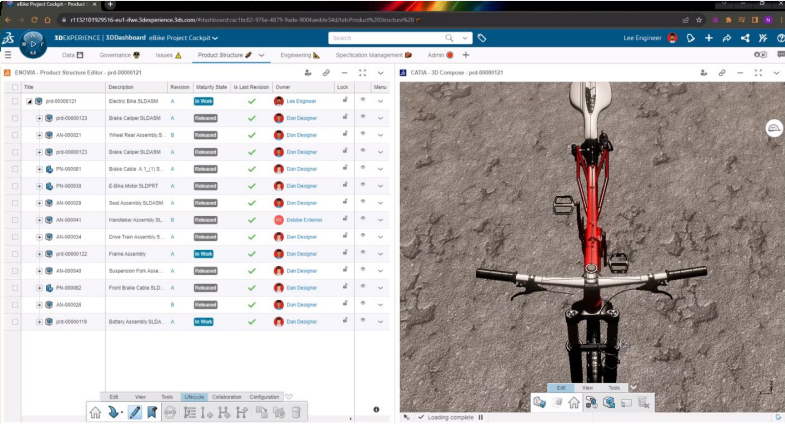

—

Manage & Control Benefits

- Governance of your engineering processes
- Management and traceability of your IP
- Maintain the end to end digital thread of your products
- Secure collaboration with external help within your tenant

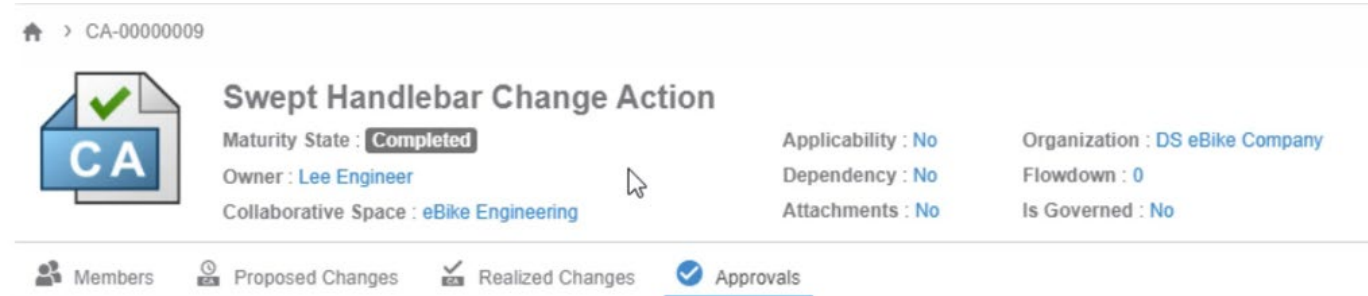

CA-00000009

Swept Handlebar Change Action

Maturity State : **Completed**

Owner : [Lee Engineer](#)

Collaborative Space : [eBike Engineering](#)

Applicability : **No**

Dependency : **No**

Attachments : **No**

Organization : [DS eBike Company](#)

Flowdown : **0**

Is Governed : **No**

Members Proposed Changes Realized Changes **Approvals**

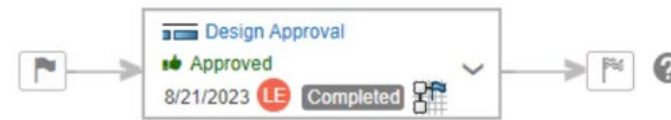

With 3DEXP

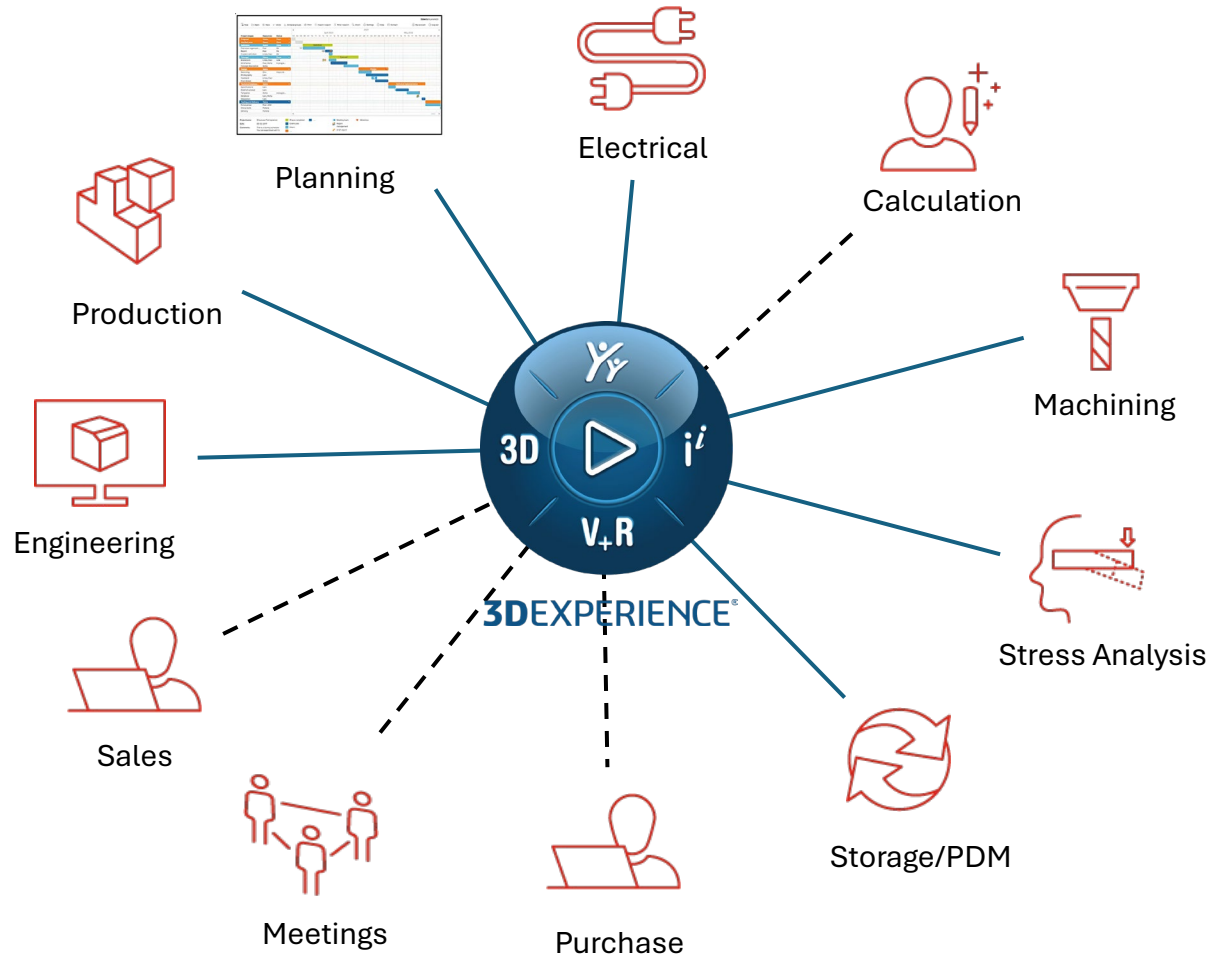

On cloud, no infrastructure and maintenance

Integrated in all 3DS brands

Standard Office integration



Many applications ..

Connectors and convertors ..

SolidWorks & **Catia** and others, like ... Altium, AutoCAD, Cadence, ControlBuild, Creo, Dymola, Inventor, NX, Solid Edge, STEP, ACIS, MicroStation, Parasolid, Revit ...

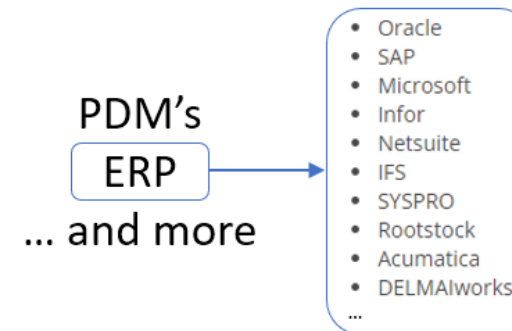

Recap + Giveaway winner

15.10 – 15:30

By Dolf Broekaart

Go Digital, Stay Human

15:30

By Christian Kromme



Break-out sessions

	ROOM 1 AUDITORIUM	ROOM 2 ZEEMAN	ROOM 3 LORENTZ	ROOM 4 ZERNIKE
ROUND 1 11:45	What's New SW 25	MBSE	myCADtools & myPDMtools	DriveWorks Automation
ROUND 2 13:10	3D EXPERIENCE	Peel 3D Scanner	Formlabs	Simulation vs. Abacus
ROUND 3 14:00			Virtual Twins	BOM- Visiativ PLM
GIVEAWAY WINNEN?				DriveWorks CPQ
				Inleveren vóór 14.45
			Naam: _____	

Round 1: 11:45 – 12:30

Break: 12:30 – 13:10

Round 2: 13:10 – 13:55

Round 3: 14:00 – 14:45

Break: 14:45 – 15:10