

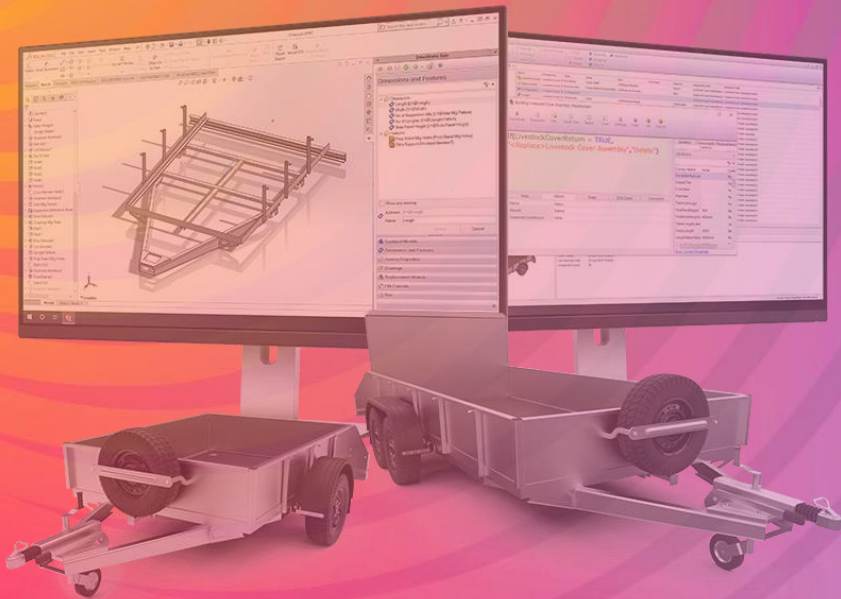

Tips voor een topdag

 **visiativ**



DriveWorks Automatisering

JEROEN SPEE



Introductie

- Jeroen Spee
- 7,5 +/- Jaar Visiativ Benelux
- 20+ DriveWorks team ervaring
- CAD | Composer | Visualize | DriveWorks | PDM
- Jeroen.Spee@Visiativ.com



Agenda

—

- Introductie DriveWorks
- Uitdagingen
- DriveWorks Functionaliteiten
- Software
- Documentatie / Diensten



INTRODUCTIE DRIVEWORKS

Introductie DriveWorks?

- Software bedrijf gespecialiseerd in het automatiseren van engineering,- verkoop processen (CPQ)
- Gevestigd in Warrington (The Barn)
- Opgericht in 2001 door Glen Smith en Maria Sarkar
- 60+ werknemers
- Queen 's awards (succesvolle innovatieve producten)
- Gold partner van SOLIDWORKS....
- SOLDWORKS ADD-in

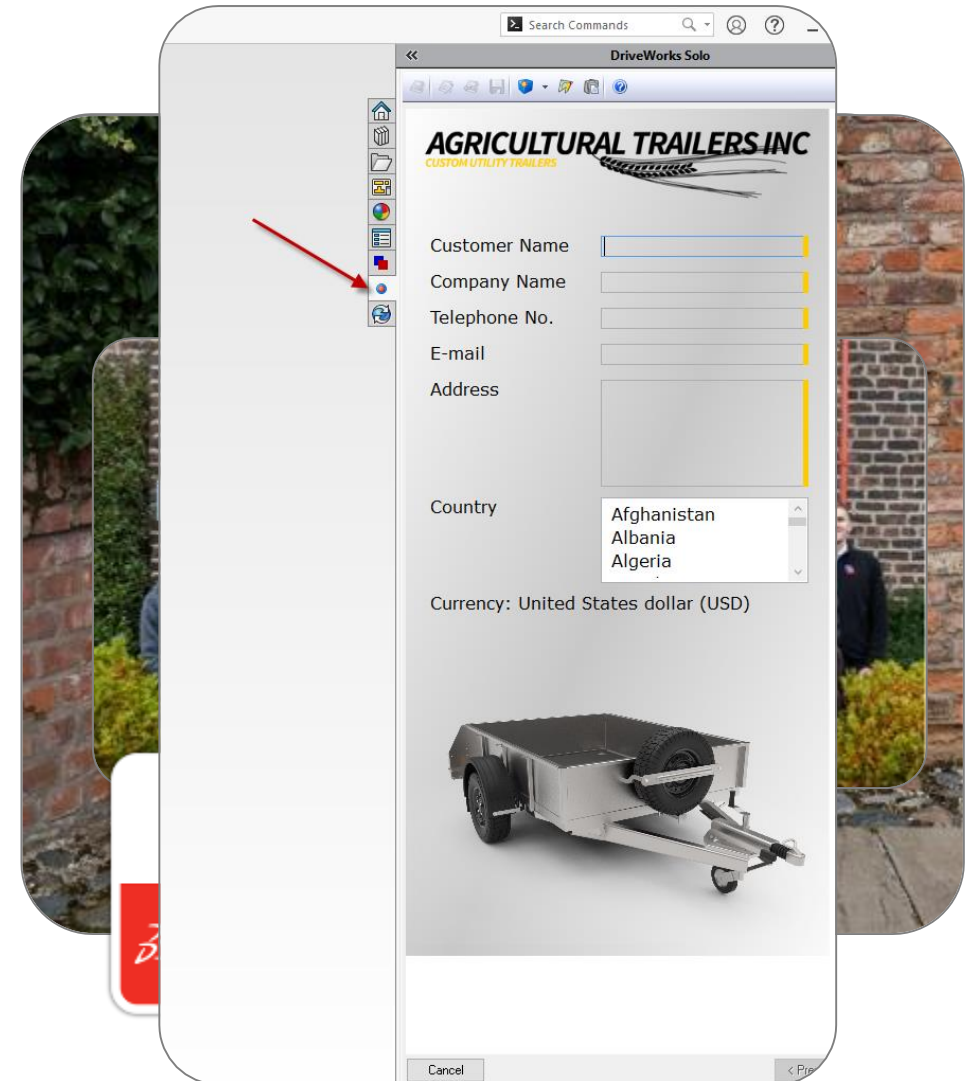

UITDAGINGEN...

Uitdagingen

—



Personeelstekort / Verloop / 1 Persoon met alle kennis



Maatwerk kost veel tijd om te engineeren



Repetitieve engineering taken zijn saai.....



Ontwerp,- offerte fouten



Complexe modellen met Equations, Design Tables en Configuraties



Geen standaard (voorraad)

DRIVEWORKS FUNCTIONALITEITEN

DriveWorks Functionaliteiten

—

- Variabelen / Constante / Tabellen
- SOLIDWORKS Files
- SW Drawings / PDF
- Stuklijsten / Offertes
- E-mails
- Afbeeldingen van het CAD / 3Dpreview model
- Overige 3D/2D formats STEP, DXF, BIM enz...
- Productiedata naar ERP

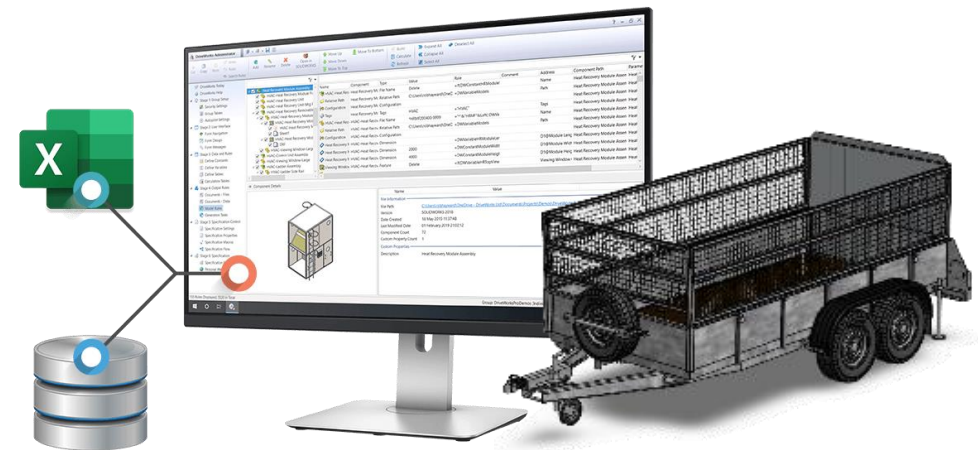

DriveWorks Functionaliteiten

Export files

- SW CAD
- SW Drawings
- Document templates

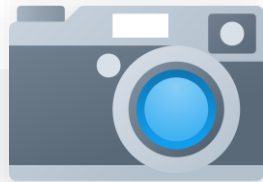

1. Capture

Vang de parameters die je wil aansturen.

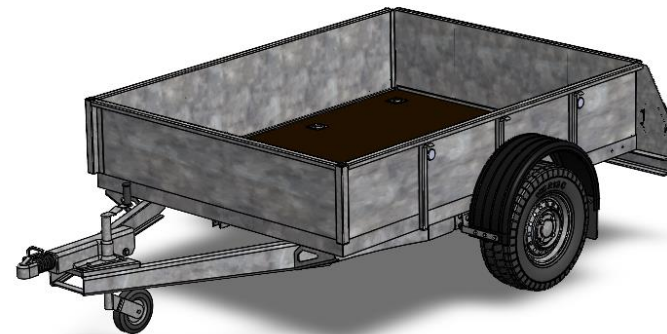

AGRICULTURAL TRAILERS INC QUOTATION

ITEM NO.	DESCRIPTION	QTY	UNIT
CH0014842.4	Fabricated Chassis - 3050x1440x450 (From Axle)	1	EA
FP10484.4	Front Panel - 1440mm x 400mm	1	EA
FCF48.4	Front Corner Pile - 480mm	1	EA
SFPC02048.4	Side Panel Set - 3050mm x 400mm	1	EA
SLPC02048.4	Side Panel LH - 3050mm x 400mm	1	EA
FLP02048.4	Floor Panel - 3050mm x 1440mm	1	EA
AS0148.4	Axle & HUB Assembly - 1480mm	1	EA
SUSP-1224	Suspension Assembly	1	EA
WHT-1224	13 inch Whitewall 1481/132 Type	1	EA
TUB-1224	Tub 1224mm	1	EA
FRONT-ROCK-MOUNTING-BRACKET	Front Rock Mounting Bracket	1	EA
FRONT-MOUNTING-PANEL-SET	Front Mounting Panel Set - 480mm	1	EA
FRONT-MOUNTING-PANEL-LH	Front Mounting Panel LH - 480mm	1	EA
FRONT-MOUNTING-PANEL-RH	Front Mounting Panel RH - 480mm	1	EA
LIGHTING-UNIT	Lighting Unit - 144	1	EA

DriveWorks Functionaliteiten

—



1. Capt

Vang de parameters
wil aanstu



2. Build UI

Bouw een interface voor
het invullen van de
kenmerken.

Formulieren

- Invulvelden
- Lijsten
- Afbeeldingen
- 3D preview model

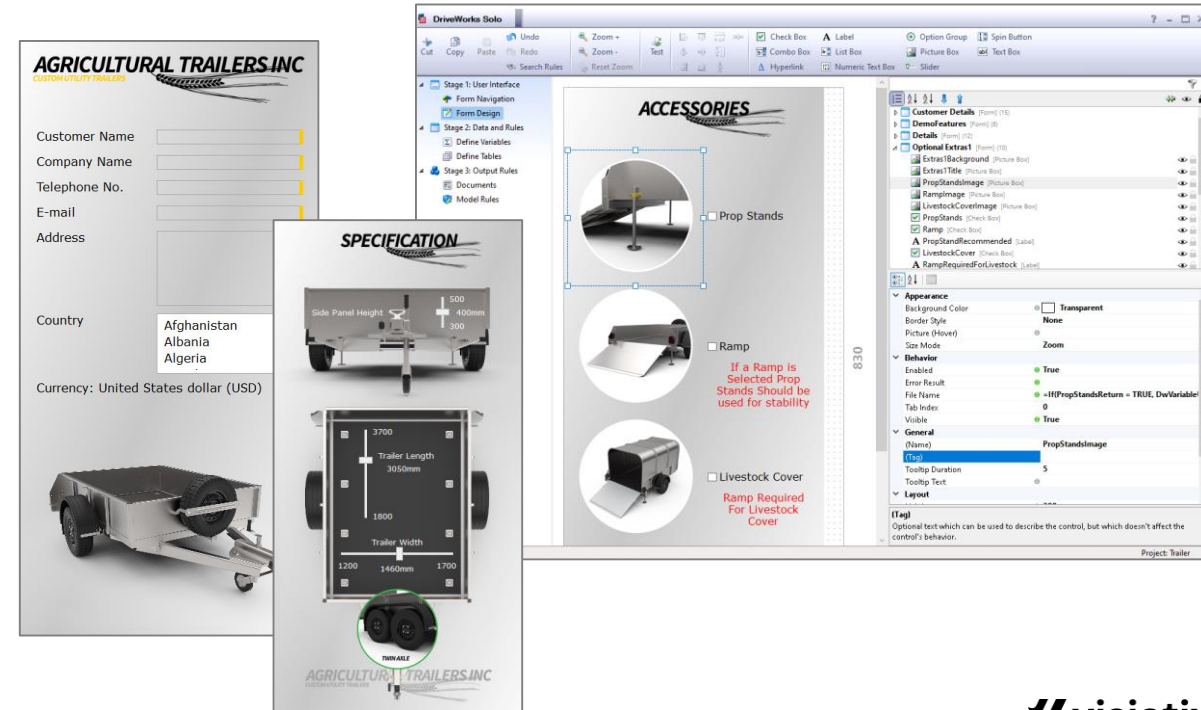

DriveWorks Functionaliteiten

Regels Bouwen

- Statische,- Dynamische tabellen
- Variabelen
- Constanten

1. C
Va
paramet
wil a

2. Bu

Bou
interfa
het inv
de ken

$f(x)$

3. Create Rules

Link invulvelden
aan de gevangen
parameters met
regels en logica.

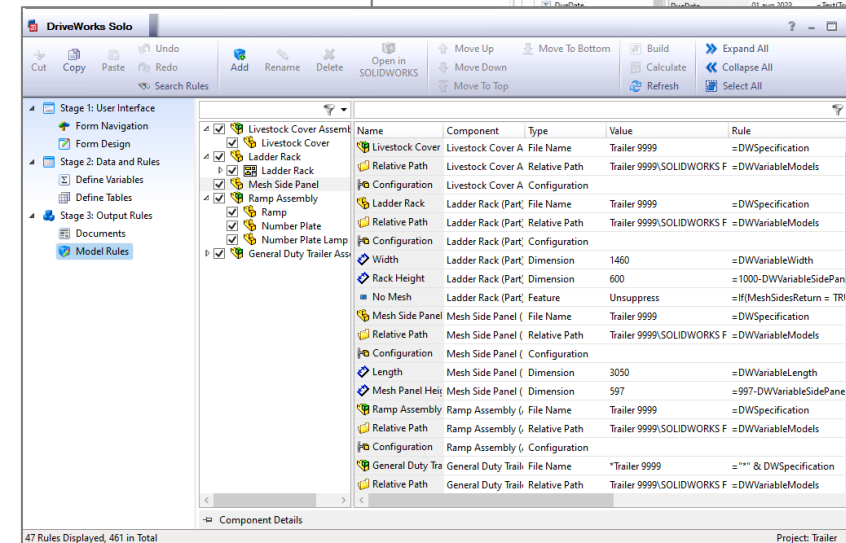
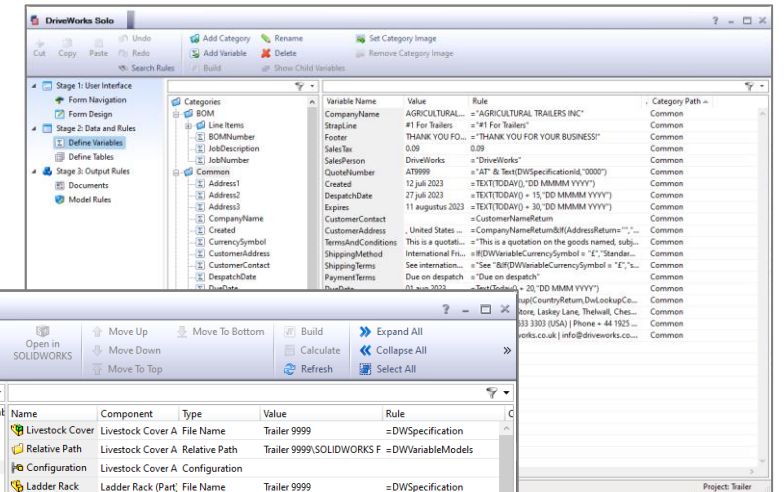

DriveWorks Functionaliteiten

—

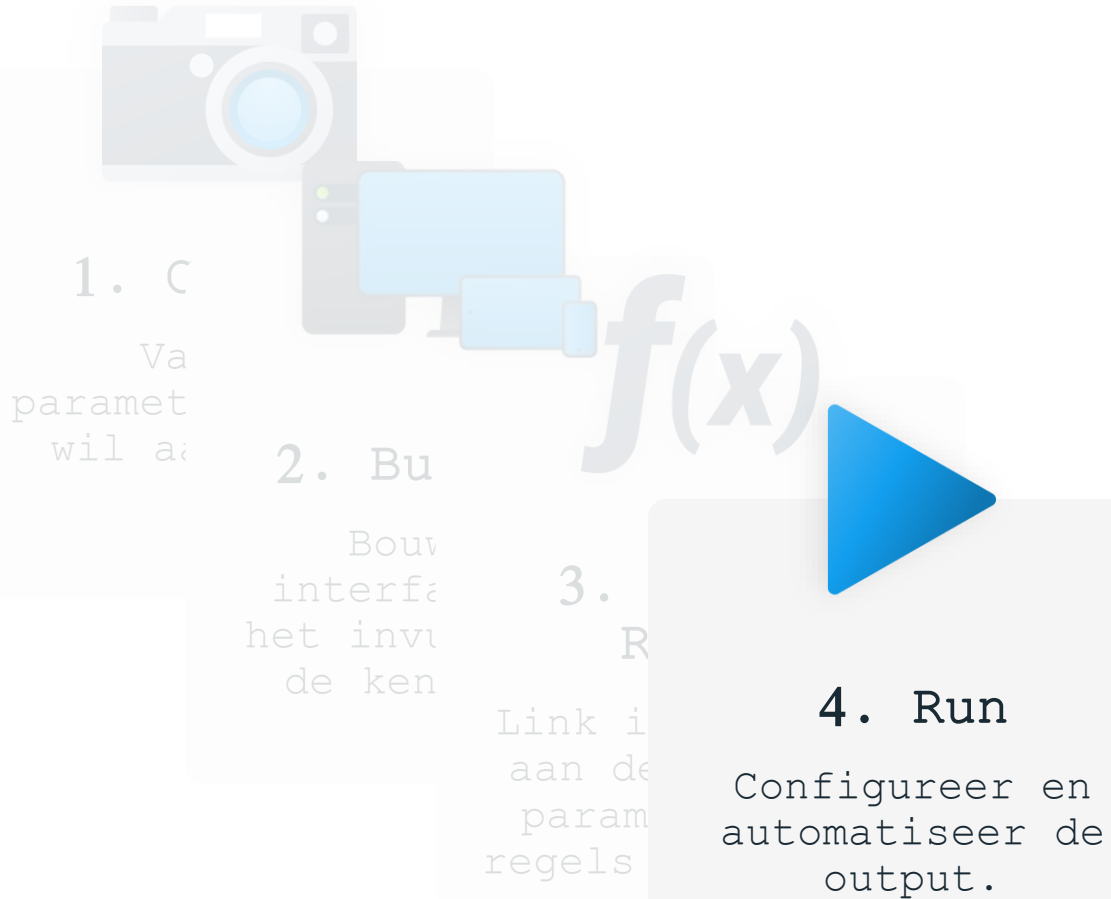

Configureren

- DriveWorks Add-in
- DriveWorks Administrator
- DriveWorks Live / Website

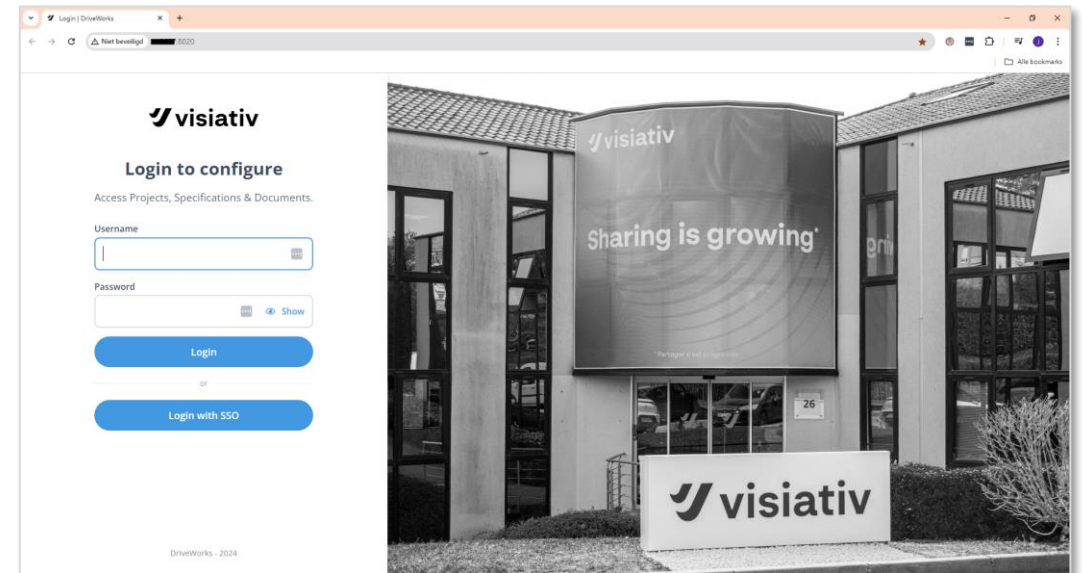

DriveWorks Functionaliteiten

De '4 stappen naar automatisering' met DriveWorks



DriveWorks Functionaliteiten LIVE

DriveWorks Conveyor

- Input formulieren
- Kennisregels opstellen
- Genereren van documenten
- Workflow / iteratie

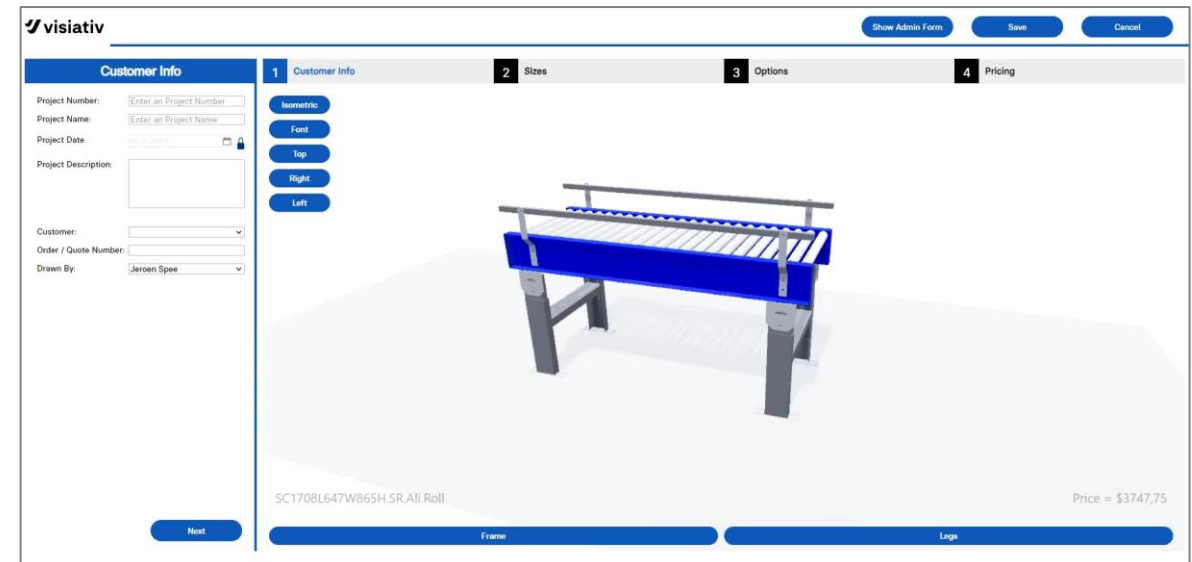
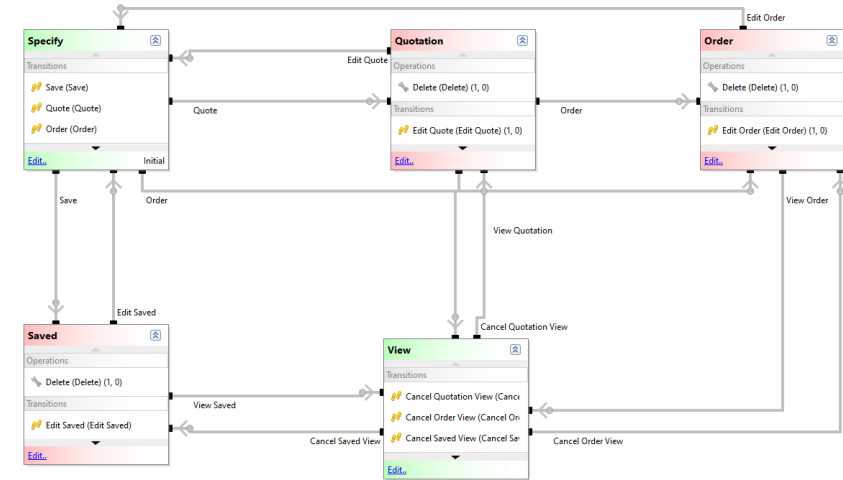

SOFTWARE

DRIVEWORKS SOFTWARE

Configurator starten

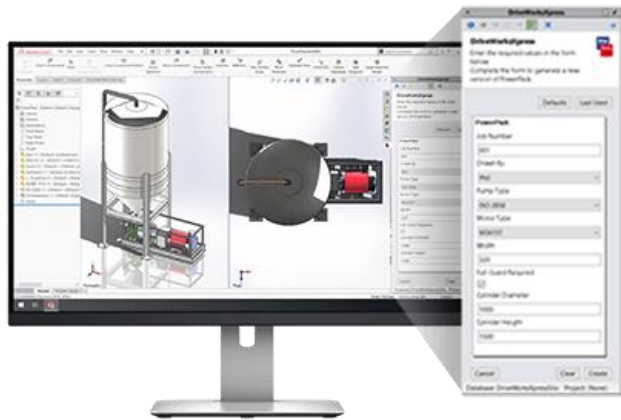

DriveWorks Express

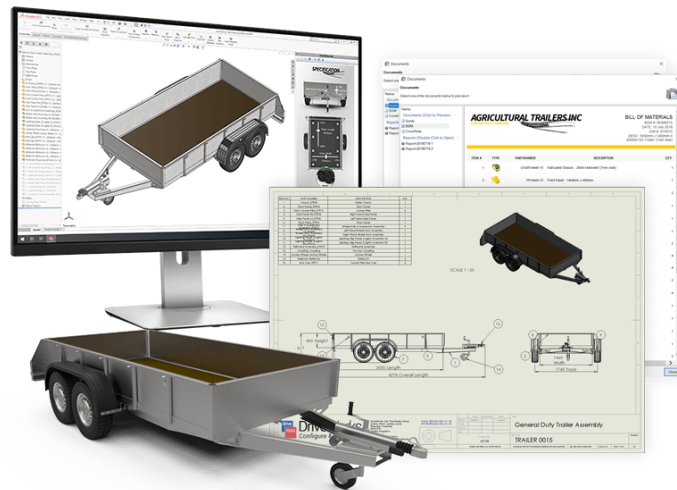

DriveWorks SOLO
administrator

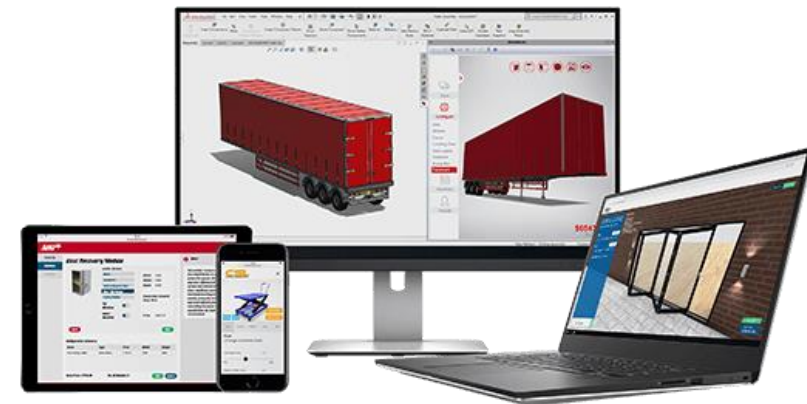

DriveWorks PRO
Administrator
Autopilot
Live

DriveWorks Pro – Software



DOCUMENTATIE

Online documentatie

- DriveWorks SOLO en Pro help pagina
- Duidelijke uitleg met voorbeelden!
- Voorbeeld projecten / Inspiratie

<https://driveworkslive.com/>

- ROI Calculator (solo)

<https://my.driveworks.co.uk/resources/roi-calculator/>

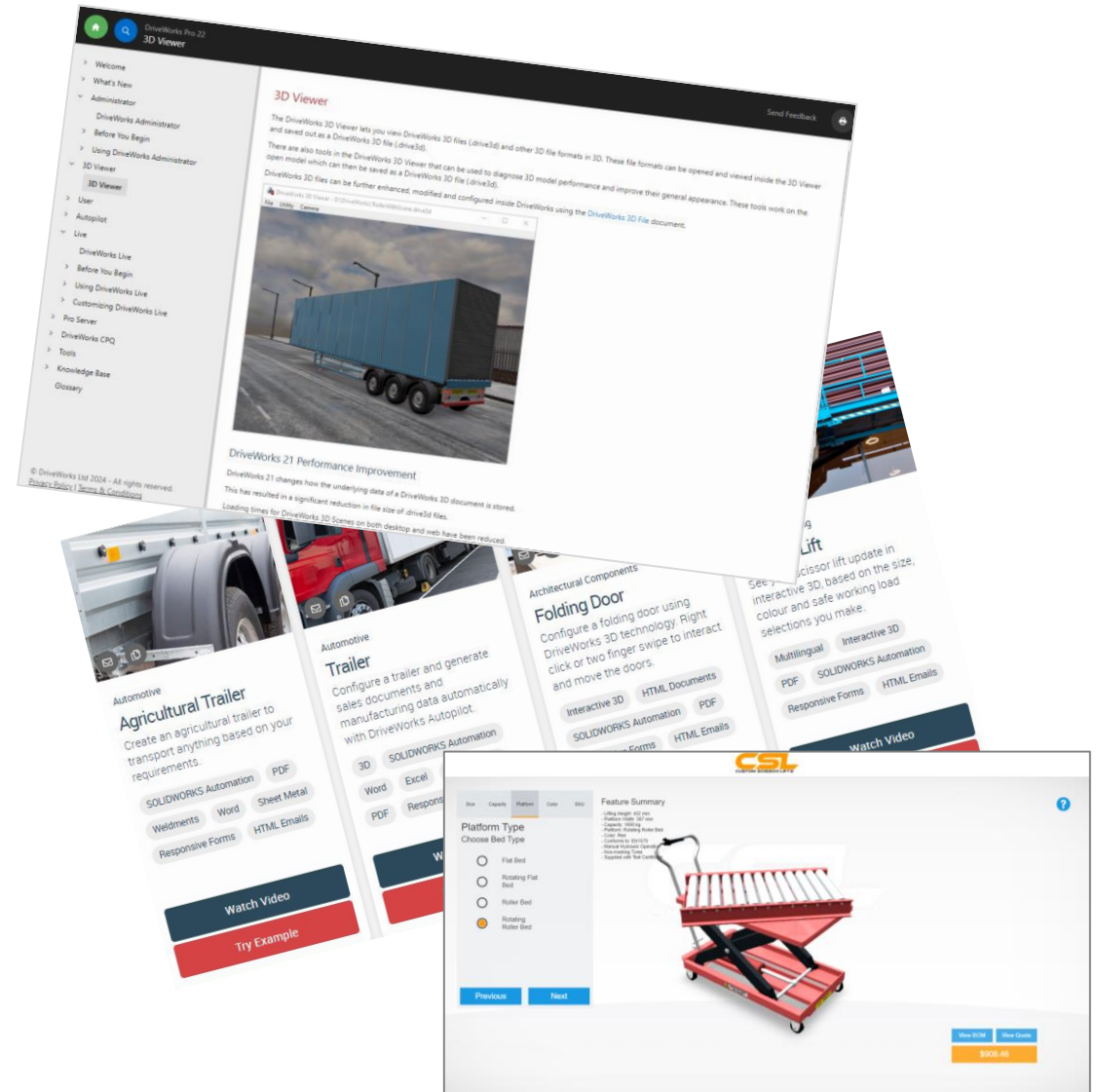

30 DAGEN TRIALVERSIE

SOLO Trial



Gratis online DriveWorks Solo trial

Onderzoek kosteloos de talloze mogelijkheden van DriveWorks Solo: vul het formulier hiernaast in. Wij nemen zo snel mogelijk contact op om je trialversie te activeren.

Waarom Visiativ als DriveWorks partner?

Wij zijn een officiële en ervaren DriveWorks reseller. We werken al jaren nauw samen met DriveWorks om zo de meest uitdagende implementaties te realiseren voor onze klanten. Kortom, we beschikken over ervaren experts die bovendien hun kennis op peil houden en regelmatig op bezoek gaan bij DriveWorks in Groot-Brittannië om over de laatste ontwikkelingen te leren.

E-mail*

Voornaam*

Achternaam*

Telefoonnummer*

Welke omschrijving past het beste bij je functie?*

Vestigingsland van je bedrijf*

Wij verwerken je gegevens om je een trialversie van DriveWorks Solo aan te kunnen bieden. Door dit formulier in te vullen, ga je ermee akkoord dat wij je de benodigde link voor de trialversie via de mail naar je opsturen. Je kan je op elk moment uitschrijven voor onze mailingen.

Vraag de trialversie aan

<https://www.visiativ.nl/probeer-gratis-driveworks-solo>

Visiativ Diensten

- Software
- Training
- Consultancy
- Projectplan
- PoC Project



Recap + Giveaway
winner

15.10 – 15:30

By Dolf Broekaart

Go Digital, Stay
Human

15:30

By Christian Kromme



Break-out sessions

	ROOM 1 AUDITORIUM	ROOM 2 ZEEMAN	ROOM 3 LORENTZ	ROOM 4 ZERNIKE
ROUND 1 11:45	What's New SW 25	MBSE	myCADtools & myPDMtools	Formlabs BOM- Visiativ PLM
ROUND 2 13:10		3D EXPERIENCE	Peel 3D Scanner	Virtual Twins
ROUND 3 14:00				DriveWorks Automation Simulation vs. Abaqus DriveWorks CPQ
GIVEAWAY WINNER?				

Naam: _____

Inleveren vóór 14.45

Round 1:

11:45 – 12:30

Break:

12:30 – 13:10

Round 2:

13:10 – 13:55

Round 3:

14:00 – 14:45

Break:

14:45 – 15:10

VRAGEN?